



2015

CATÁLOGO

CATALOGUE

www.quadysrem.pl

www.sklep-atv.pl

xrw

RACING PARTS

www.centrum-brp.pl

EMPRESA

Quady Śrem tel. 61 28 35 657 email: biuro@sklepatv.pl

COMPANY

A XRW é uma jovem empresa que nasceu em Outubro de 2005 na zona industrial de Vila Verde, pertence ao concelho de Oliveira do Bairro e ao distrito de Aveiro. Com o objectivo de garantir qualidade, aliada ao excelente design e inovação a XRW dedica-se principalmente ao fabrico de proteções em duro alumínio para moto4, ATV's e UTV's, bem como, a uma vasta gama de outros artigos.

Esta empresa tem como fundamento principal o mercado nacional e internacional onde procura inovar e otimizar sem colocar em causa a qualidade do produto final.

A XRW controla todo o processo de concepção e construção do seu equipamento. A adaptação a cada modelo é minuciosamente estudada sem margem para erro.

Durante o processo de fabrico o alumínio sofre vários tipos de tensões, especialmente nas zonas de dobragem e de soldadura, que enfraquecem a resistência mecânica das peças.

Por este motivo, no final do processo produtivo, **TODAS** as peças XRW, são submetidas a Tratamento Térmico, normalmente designado por Têmpera. (trata-se de um tratamento de alta temperatura, que devolve todas as propriedades mecânicas à liga metálica, quebrando tensões, aumentando a resistência, durabilidade e elasticidade das peças).

Este processo térmico de estabilização e aumento de resistência do alumínio, é exactamente o mesmo que é utilizado nas Industrias Automóvel e Aeronáutica.

A XRW orgulha-se de ser a única empresa Europeia a utilizar este processo no fabrico de peças metálicas para acessórios de ATV/Quad e OFF Road. Conhecida como a Marca dos Campeões, a XRW é a escolha da grande maioria de pilotos de TOPO a nível Europeu.

The XRW is a young company that was born in October 2005 in the industrial zone of Vila Verde, belongs to the municipality of Oliveira do Bairro and the district of Aveiro. In order to ensure quality, coupled with excellent design and innovation XRW is principally engaged in the manufacture of aluminum for protection in hard aluminum for Quad's, ATV's and UTV's, as well as a wide range of other items.

The XRW controls the entire process of design and construction of your equipment. Adapting to each model is thoroughly studied with no margin for error.

During the process of manufacturing aluminum undergoes various kinds of stress, especially in areas of bending and welding, which weakens the mechanical strength of the parts.

For this reason, at the end of the production process, **ALL** XRW parts are subjected to heat treatment, commonly called hardening. (this is a high temperature treatment, which returns all the mechanical properties of the alloy, breaking stress, increasing the strength, durability and elasticity of the pieces).

This thermal stabilization and increased resistance of aluminum, is exactly the same as is used in the automotive and aeronautics.

The XRW proud to be the only European company to use this process to manufacture metal parts accessories for ATV / Quad and Off Road. Known as the Brand Champions, the XRW is the choice of most of the top riders at the European level.

XRW Racing Parts!



ACABAMENTOS FINISHING



PR
Preto liso mate para exterior
Matte black finish for exterior



PO
Polido (brilhante).
Polishing finishing (shining).



www.quadysrem.pl

www.sklep-atv.pl

www.centrum-brp.pl



ÍNDICE

INDEX

UTV

POLARIS

RZR 800	4
RZR 800 S	
RZR 900 S	
RZR 900 XP	
RZR 900 XP/ RZR4-900 XP	
RZR 1000 XP/ RZR4 1000 XP	
ACE 570 SP	

CAN AM

Maverick 1000 XRS/ 1000 XXC	20
Commander 1000	

ARTIC CAT

Wild Cat 1000	26
---------------	----

ATV

KIT ATV

31

BUMPER ATV

31

CAN AM RENEGADE

500/ 800/ 1000 X XC 2012	32
--------------------------	----

CAN AM OUTLANDER

1000 MAXX 2013 / 1000 Xmr 2013	33
--------------------------------	----

POLARIS

SCRAMBLER XP 850	34
------------------	----

CAN AM RENEGADE

500/ 800	35
----------	----

Quad

BUMPERS

39

NERF BAR

60

KIT QUAD'S

65

PROTEÇÕES EM PHD

66

PROTEÇÕES ALUMÍNIO

70

Acessórios

Patins

75

Cavaletes

75

Pegas

76

Suporte Traseiro

77

Proteção Farol

77

Alargadores

78

Correias

79

Placa PHD

81

Fornas amortecedor

82





U T V

Quady Śrem tel. 61 28 35 657 email: biuro@sklepatv.pl



RZR

800/ 800S/ 900 XP/ RZR4-900 XP/ RZR 1000XP/
RZR4 1000XP/ ACE 570 SP / RZR 900 S

POLARIS

www.quadysrem.pl

www.sklep-atv.pl

www.centrum-brp.pl

REF	Nome/ Name	Modelo/ Models
110050501NA	Kit Completo / Complete Kit	RZR800
110050506NA	Prot. Triang. Frt / Front A. Arms Alum	RZR800
110050507NA	Prot. Triang. Trás / Back A. Arms Alum	RZR800
110050528NA	Prot. Central / Central Prot. Alum	RZR800
110051001NA	Kit Completo / Complete Kit	RZR800 - S
110051002NA	Prot. Triang. Frt / Front A. Arms Alum	RZR800 - S
110051003NA	Prot. Triang. Trás / Back A. Arms Alum	RZR800 - S
110051004NA	Prot. Central / Central Skid Plate	RZR800 - S
110051501NA	Kit Prot. 5mm (Incl. triang.) S/ Laterais	RZR 900 XP
110051502NA	Kit Prot. Complet. 5mm (Incl. Triang.)	RZR 900 XP
110051510NA	Prot. Triang. Frt / Front A. Arms Alum	RZR 900 XP
110051511NA	Prot. Triang. Trás / Back A. Arms Alum	RZR 900 XP
110051512NA	Prot. Inf. Frontal / Frontal Prot.	RZR 900 XP
110051513NA	Prot. Inf. Central / Central Prot.	RZR 900 XP
110051514NA	Prot. Inf. Traseira / Back Prot.	RZR 900 XP

Nome: Proteção Motor Alum

Composição: Alumínio - Liga 5754 - Tratamento T5

Características: Chapa (esp.) 5 mm

Name: Skid Plate Alum

Composition: Aluminum - Special Alloy 5754 with a T5 Treatment

Technical Features: Plate (thickness) 5 mm



REF	Nome/ Name	Modelo/ Models
110050502PH	Kit Prot. Motor PHD / Complete Kit PHD	RZR800
110050503PH	Prot. Central / Central Protection PHD	RZR800
110050504PH	Prot. Triang. Frt / Front A. Arms PHD	RZR800
110050505PH	Prot. Triang. Trás / Back A. Arms PHD	RZR800
110051013PH	Kit Prot. Motor PHD / Complete Kit PHD	RZR800 - S
110051015PH	Prot. Triang. Frt / Front A. Arms PHD	RZR800 - S
110051016PH	Prot. Triang. Trás / Back A. Arms Alum	RZR800 - S
110051017PH	Prot. Central / Central Protection PHD	RZR800 - S
110051503PH	Kit Prot. Complet PHD 8mm (Incl. Triang.)	RZR 900 XP
110051504PH	Prot. Triang. Frt / Front A. Arms Alum	RZR 900 XP
110051505PH	Prot. Triang. Trás / Back A. Arms Alum	RZR 900 XP
110051506PH	Prot. Central / Central Protection PHD	RZR 900 XP

Nome: Proteção Motor PHD

Composição: PHD 300 - (Polietileno de alta densidade)

Características: Chapa (esp.) 8 mm

Name: Skid Plate PHD

Composition: PHD 300 - (High density polyethylene)

Technical features: Plate (thickness) 8 mm

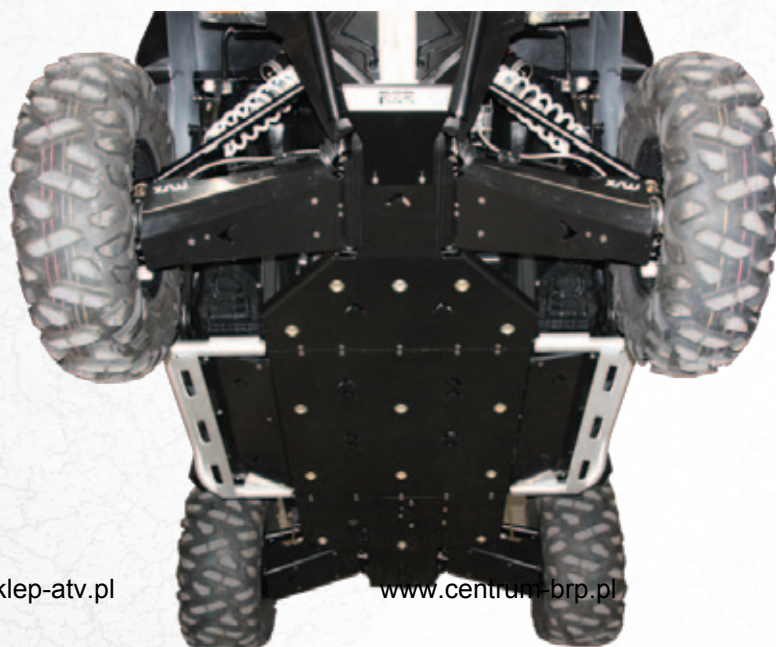



REF	Nome/ Name	Modelo/ Models
110052504NA	Kit Completo / Complete Kit Alum	RZR 1000 XP
110052516NA	Prot. Triang. Frt Alum./ Front A. Arms Alum.	RZR 1000 XP
110052517NA	Prot. Triang. Trás Alum./ Back A. Arms Alum.	RZR 1000 XP
110052525NA	Prot. Central Alum.	RZR 1000 XP

Nome: Proteção Motor Alum
Composição: Alumínio - Liga 5754 - Tratamento T5
Características: Chapa (esp.) 5 mm

Name: Skid Plate Alum
 Composition: Aluminum - Special Alloy 5754 with a T5 Treatment
 Technical Features: Plate (thickness) 5 mm



REF	Nome/ Name	Modelo/ Models
110052505PH	Kit Complet PHD	RZR 1000 XP
110052506PH	Prot. Central / Central Protection PHD	RZR 1000 XP
110052507PH	Prot. Triang. Frt / Front A. Arms PHD	RZR 1000 XP
110052508PH	Prot. Triang. Trás / Back A. Arms PHD	RZR 1000 XP

Nome: Proteção Motor PHD
Composição: PHD 300 - (Polietileno de alta densidade)
Características: Chapa (esp.) 8 mm

Name: Skid Plate PHD
 Composition: PHD 300 - (High density polyethylene)
 Technical features: Plate (thickness) 8 mm

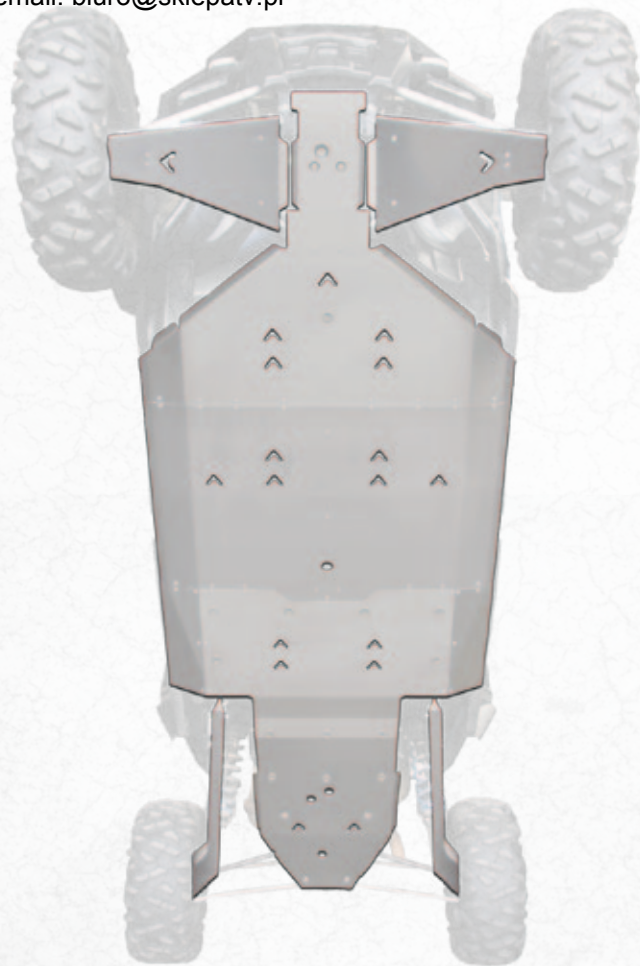

REF	Nome/ Name	Modelo/ Models
110052003NA	Kit Completo / Complete Kit Alum	RZR 4 900 XP
110052005NA	Prot. Triang. Frt. Alum./ Front A. Arms Alum.	RZR 4 900 XP
110052006NA	Prot. Triang. Trás Alum./ Back A. Arms Alum.	RZR 4 900 XP
110054003NA	Kit Completo / Complete Kit Alum	RZR4 1000 XP
110054011NA	Prot. Triang. Frt. Alum./ Front A. Arms Alum.	RZR4 1000 XP
110054012NA	Prot. Triang. Trás Alum./ Back A. Arms Alum.	RZR4 1000 XP

Nome: Proteção Motor Alum

Composição: Alumínio - Liga 5754 - Tratamento T5

Características: Chapa (esp.) 5 mm

Name: Skid Plate Alum

Composition: Aluminum - Special Alloy 5754 with a T5 Treatment

Technical Features: Plate (thickness) 5 mm

REF	Nome/ Name	Modelo/ Models
110052004PH	Kit Complet PHD	RZR 4 900 XP
110054004PH	Kit Complet PHD	RZR4 1000 XP
110054008PH	Prot. Triang. Frt / Front A. Arms PHD	RZR4 1000 XP
110054009PH	Prot. Triang. Trás / Back A. Arms PHD	RZR4 1000 XP

Nome: Proteção Motor PHD

Composição: PHD 300 - (Polietileno de alta densidade)

Características: Chapa (esp.) 8 mm

Name: Skid Plate PHD

Composition: PHD 300 - (High density polyethylene)

Technical features: Plate (thickness) 8 mm

Polaris ACE 570 SP

Quadry Śrem tel: 61 28 35 657 email: biuro@sklepatv.pl



REF	Nome/ Name	Modelo/ Models
110053005NA	Kit Completo / Complete Kit Alum	ACE 570 SP

Nome: Proteção Motor Alum
Composição: Alumínio - Liga 5754 - Tratamento T5
Características: Chapa (esp.) 5 mm

Name: Skid Plate Alum
Composition: Aluminum - Special Alloy 5754 with a T5 Treatment
Technical Features: Plate (thickness) 5 mm



REF	Nome/ Name	Modelo/ Models
110053006PH	Kit Complet PHD	ACE 570 SP

Nome: Proteção Motor PHD
Composição: PHD 300 - (Polietileno de alta densidade)
Características: Chapa (esp.) 8 mm

Name: Skid Plate PHD
Composition: PHD 300 - (High density polyethylene)
Technical features: Plate (thickness) 8 mm

Polaris

RZR 900 S

Quadry - Srem tel. 61 28 35 657 email: biuro@sklepatv.pl

REF	Nome/ Name	Modelo/ Models
110053504NA	Kit Completo / Complete Kit Alum	RZR 900 S
110053520NA	Prot. Central / Central Protection Alum	RZR 900 S
110053512NA	Prot. Triang. Frt. Alum./ Front A. Arms Alum.	RZR 900 S
110053513NA	Prot. Triang. Trás Alum./ Back A. Arms Alum.	RZR 900 S

Nome: Proteção Motor Alum

Composição: Alumínio - Liga 5754 - Tratamento T5

Características: Chapa (esp.) 5 mm

Name: Skid Plate Alum

Composition: Aluminum - Special Alloy 5754 with a T5 Treatment

Technical Features: Plate (thickness) 5 mm



REF	Nome/ Name	Modelo/ Models
110053505PH	Kit Complet PHD	RZR 900 S
110053506PH	Prot. Central / Central Protection PHD	RZR 900 S
110053507PH	Prot. Triang. Frente/ Front A. Arms PHD	RZR 900 S
110053508PH	Prot. Triang. Trás/ Back A. Arms PHD	RZR 900 S

Nome: Proteção Motor PHD

Composição: PHD 300 - (Polietileno de alta densidade)

Características: Chapa (esp.) 8 mm

Name: Skid Plate PHD

Composition: PHD 300 - (High density polyethylene)

Technical features: Plate (thickness) 8 mm





REF	Nome/ Name	Modelo/ Models
110050508PR	Nerf Bar P1 Black	RZR 800
110050508PO	Nerf Bar P1 Polish	RZR 800
110051007PR	Nerf Bar P1 Black	RZR 800 S
110051007PO	Nerf Bar P1 Polish	RZR 800 S

Nome: Nerf Bar P1
Composição: Alumínio - Liga 6060 - Tratamento T5
Características: Tubo Ø 35x2.5

Name: Nerf Bar P1
 Composition: Aluminum - Special alloy 6060 with a T5 treatment
 Technical features: Pipe Ø 35x2.5



REF	Nome/ Name	Modelo/ Models
110050509PR	Nerf Bar P2 Black	RZR 800
110050509PO	Nerf Bar P2 Polish	RZR 800
110051008PR	Nerf Bar P2 Black	RZR 800 S
110051008PO	Nerf Bar P2 Polish	RZR 800 S

Nome: Nerf Bar P2
Composição: Alumínio - Liga 6060 - Tratamento T5
Características: Tubo Ø 35x2.5

Name: Nerf Bar P2
 Composition: Aluminum - Special alloy 6060 with a T5 treatment
 Technical features: Pipe Ø 35x2.5



REF	Nome/ Name	Modelo/ Models
110051515PR	Nerf Bar P3 Black	RZR 900 XP
110051515NA	Nerf Bar P3 Natural	RZR 900 XP

Nome: Nerf Bar P3
Composição: Alumínio - Liga 6060 - Tratamento T5
Características: Tubo Ø 35x2.5

Name: Nerf Bar P3
 Composition: Aluminum - Special alloy 6060 with a T5 treatment
 Technical features: Pipe Ø 35x2.5



REF	Nome/ Name	Modelo/ Models
110052002PR	Nerf Bar P5 Black	RZR 4 900 XP
110052002NA	Nerf Bar P5 Natural	RZR 4 900 XP

Nome: Nerf Bar P5
Composição: Alumínio - Liga 6060 - Tratamento T5
Características: Tubo Ø 35x2.5

Name: Nerf Bar P5
 Composition: Aluminum - Special alloy 6060 with a T5 treatment
 Technical features: Pipe Ø 35x2.5



REF	Nome/ Name	Modelo/ Models
110052501PR	Nerf Bar P6 Black	RZR 1000 XP
110052501NA	Nerf Bar P6 Natural	RZR 1000 XP
110053501PR	Nerf Bar P6 Black	RZR 900 S
110053501NA	Nerf Bar P6 Natural	RZR 900 S

Nome: Nerf Bar P6
Composição: Alumínio - Liga 6060 - Tratamento T5
Características: Tubo Ø 35x2.5

Name: Nerf Bar P6
 Composition: Aluminum - Special alloy 6060 with a T5 treatment
 Technical features: Pipe Ø 35x2.5

REF	Nome/ Name	Modelo/ Models
110052502PR	Nerf Bar P7 Black	RZR 1000 XP
110052502NA	Nerf Bar P7 Natural	RZR 1000 XP
110053502PR	Nerf Bar P7 Black	RZR 900 S
110053502NA	Nerf Bar P7 Natural	RZR 900 S

Nome: Nerf Bar P7

Composição: Alumínio - Liga 6060 - Tratamento T5
Características: Tubo Ø 35x2.5

Name: Nerf Bar P7

Composition: Aluminum - Special alloy 6060 with a T5 treatment

Technical features: Pipe Ø 35x2.5



REF	Nome/ Name	Modelo/ Models
110053001PR	Nerf Bar P8 Black	ACE 570 SP
110053001NA	Nerf Bar P8 Natural	ACE 570 SP

Nome: Nerf Bar P8

Composição: Alumínio - Liga 6060 - Tratamento T5
Características: Tubo Ø 35x2.5

Name: Nerf Bar P8

Composition: Aluminum - Special alloy 6060 with a T5 treatment

Technical features: Pipe Ø 35x2.5



REF	Nome/ Name	Modelo/ Models
110054001PR	Nerf Bar P9 Black	RZR4 1000 XP

Nome: Nerf Bar P9

Composição: Alumínio - Liga 6060 - Tratamento T5
Características: Tubo Ø 35x2.5

Name: Nerf Bar P9

Composition: Aluminum - Special alloy 6060 with a T5 treatment

Technical features: Pipe Ø 35x2.5



REF	Nome/ Name	Modelo/ Models
110054002PR	Nerf Bar P10 Black	RZR4 1000 XP

Nome: Nerf Bar P10

Composição: Alumínio - Liga 6060 - Tratamento T5
Características: Tubo Ø 35x2.5

Name: Nerf Bar P10

Composition: Aluminum - Special alloy 6060 with a T5 treatment

Technical features: Pipe Ø 35x2.5



REF	Nome/ Name	Modelo/ Models
110050520FP	Fitas Roll Bar / Belt Roll Cage	RZR 800
110050521FP	Fitas para Trás Roll Bar / Back Belt Roll Cage	RZR 800
110051010FP	Fitas Roll Bar / Belt Roll Cage	RZR 800 S
110051011FP	Fitas para Trás Roll Bar / Back Belt Roll Cage	RZR 800 S
110051517FP	Fitas Roll Bar / Belt Roll Cage	RZR 900 XP
110051518FP	Fitas para Trás Roll Bar / Back Belt Roll Cage	RZR 900 XP
110052518FP	Fitas Roll Bar / Belt Roll Cage	RZR 1000 XP
110053514FP	Fitas Roll Bar / Belt Roll Cage	RZR 900 S

Nome: FITAS ROLL BAR

Composição: Tecidas em Polipropileno
Características: Pretas com XRW Vermelho / Pretas com XRW Branco

Name: BELT ROLL BAR

Composition: Woven in Polypropylene

Technical features: Black color with XRW red / Black color with XRW white





REF	Nome/ Name	Modelo/ Models
110050522PR	Roll Bar S2	RZR 800
110051012PR	Roll Bar S2	RZR 800 S
110051507PR	Roll Bar S2	RZR 900 XP
110051508PR	Roll Bar AP Radiador/ Roll Cage with Radiator Support	RZR 900 XP
110052513PR	Roll Bar S (Standart)	RRZR 1000 XP
110052514PR	Roll Bar AP (Apoio Radiador)/ (Radiator Support)	RZR 1000 XP
110052515PR	Roll Bar AP2 (Radiator Sup.) DIN 25CrMO4	RZR 1000 XP

Nome: Roll Bar S2

Composição: Estrutura Tubular em Aço – St37

Características: Tubo de Ø 45x2.5/ Ø40 x 2/ Ø30 x 2

Name: Roll Bar S2

Composition: Tubular Steel Structure – St37

Technical features: Pipe Ø 45x2. / Ø40 x 2/ Ø30 x 2



REF	Nome/ Name	Modelo/ Models
110050511PH	Tejadilho PHD/ Roof PHD	RZR 800
110051014PH	Tejadilho PHD/ Roof PHD	RZR 800 S
110051516PH	Tejadilho PHD/ Roof PHD	RZR 900 XP
110052511PH	Tejadilho PHD/ Roof PHD	RZR 1000 XP
110053510PH	Tejadilho PHD/ Roof PHD	RZR 900 S

Nome: Tejadilho PHD

Composição: PHD 300 - (Polietileno de alta densidade)

Características: Chapa (esp.) 6 mm

Name: Skid Plate PHD

Composition: PHD 300 - (High density polyethylene)

Technical features: Plate (thickness) 6 mm



REF	Nome/ Name	Modelo/ Models
110050525PR	Tejadilho Al./ Roof Al. Original Roll Bar	RZR 800
110050526PR	Tejadilho Al./ Roof Al. XRW Roll Bar	RZR 800
110051023PR	Tejadilho Al./ Roof Al. Original Roll Bar	RZR 800 S
110051024PR	Tejadilho Al./ Roof Al. XRW Roll Bar	RZR 800 S
110051521PR	Tejadilho Al./ Roof Al. Original Roll Bar	RZR 900 XP
110051522PR	Tejadilho Al./ Roof Al. XRW Roll Bar	RZR 900 XP
110052511PR	Tejadilho Alum./ Roof Alum.	RZR 1000 XP
110053510PR	Tejadilho Alum./ Roof Alum. Black	RZR 900 S

Nome: Tejadilho Alumínio

Composição: Alumínio - Liga 5754 - Tratamento T5

Características: Chapa (esp.) 2,5 mm

Name: Aluminium Roof

Composition: Special alloy 5754 with a T5 treatment

Technical features: Plate (thickness) 2,5 mm



REF	Nome/ Name	Modelo/ Models
110054005PR	Tejadilho Alum./ Roof Aluminium Black	RZR4 1000 XP
110054005NA	Tejadilho Alum./ Roof Aluminium Natural	RZR4 1000 XP

Nome: Tejadilho Alumínio

Composição: Alumínio - Liga 5754 - Tratamento T5

Características: Chapa (esp.) 2,5 mm

Name: Aluminium Roof

Composition: Special alloy 5754 with a T5 treatment

Technical features: Plate (thickness) 2,5 mm

REF	Nome/ Name	Modelo/ Models
110050513PR	Kit Portas/ Doors RX - Black	RZR 800
110051019PR	Kit Portas/ Doors RX - Black	RZR 800 S
110051529PR	Kit Portas/ Doors RX - Black	RZR 900 XP

Nome: Portas RX

Composição: Alumínio - Liga 6060 - Tratamento T5

Características: Tubo Ø 35x2.5 com almofada de chapa (esp.) 2.5mm

Name: RX Door

Composition: Aluminum - Special alloy 6060 with a T5 treatment

Technical features: Pipe Ø 35x2.5 with plate (thickness) 2.5mm



REF	Nome/ Name	Modelo/ Models
110050514PR	Kit Portas Preto/ Doors RXR Black	RZR 800
110050514ES	Kit Portas Escovada/ Doors RXR Brushed	RZR 800
110051020PR	Kit Portas Preto/ Doors RXR Black	RZR 800 S
110051020ES	Kit Portas Escovada/ Doors RXR Brushed	RZR 800 S
110051530PR	Kit Portas Preto/ Doors RXR Black	RZR 900 XP
110051530ES	Kit Portas Escovada/ Doors RXR Brushed	RZR 900 XP
110052520ZB	Kit Fecho Portas/ Kit Doors Lock	RZR 1000 XP

Nome: Porta RXR

Composição: Alumínio - Liga 6060 - Tratamento T5

Características: Tubo Ø 35x2.5 com almofada de chapa (esp.) 2.5mm

Name: RXR Door

Composition: Aluminum - Special alloy 6060 with a T5 treatment

Technical features: Pipe Ø 35x2.5 with plate (thickness) 2.5mm



REF	Nome/ Name	Modelo/ Models
110052001PR	Kit Portas/ Doors Black Standart	RZR 4 900 XP

Nome: Portas Standard

Composição: Alumínio - Liga 6060 - Tratamento T5

Características: Tubo Ø 35x2.5

Name: Standard Door

Composition: Aluminum - Special alloy 6060 with a T5 treatment

Technical features: Pipe Ø 35x2.5



REF	Nome/ Name	Modelo/ Models
110052528PR	Kit Portas/ Doors RXR 1 (for original closing) - Black	RZR 1000 XP
110052529PR	Kit Portas/ Doors RXR 2 (for XRW closing) - Black	RZR 1000 XP

Nome: Portas RXR

Composição: Alumínio - Liga 6060 - Tratamento T5

Características: Tubo Ø 35x2.5

Name: RXR Door

Composition: Aluminum - Special alloy 6060 with a T5 treatment

Technical features: Pipe Ø 35x2.5



REF	Nome/ Name	Modelo/ Models
110050512PR	Kit Portas/ Doors Standard Black	RZR 800
110050512PO	Kit Portas/ Doors Standard Polish	RZR 800
110051018PR	Kit Portas/ Doors Standard Black	RZR 800 S
110051018PO	Kit Portas/ Doors Standard Polish	RZR 800 S
110051528PR	Kit Portas/ Doors Standard Black	RZR 900 XP
110051528PO	Kit Portas/ Doors Standard Polish	RZR 900 XP

Nome: Porta Standard

Composição: Alumínio - Liga 6060 - Tratamento T5

Características: Tubo Ø 35x2.5 com almofada de chapa (esp.) 2.5mm

Name: Standard Door

Composition: Aluminum - Special alloy 6060 with a T5 treatment

Technical features: Pipe Ø 35x2.5 with plate (thickness) 2.5mm





REF	Nome/ Name	Modelo/ Models
110053002PR	Kit Portas/ Doors Black RXR	ACE 570 SP
110053002NA	Kit Portas/ Doors Natural RXR	ACE 570 SP

Nome: Portas RXR
Composição: Alumínio - Liga 6060 - Tratamento T5
Características: Tubo Ø 35x2.5

Name: RXR Door
 Composition: Aluminum - Special alloy 6060 with a T5 treatment
 Technical features: Pipe Ø 35x2.5

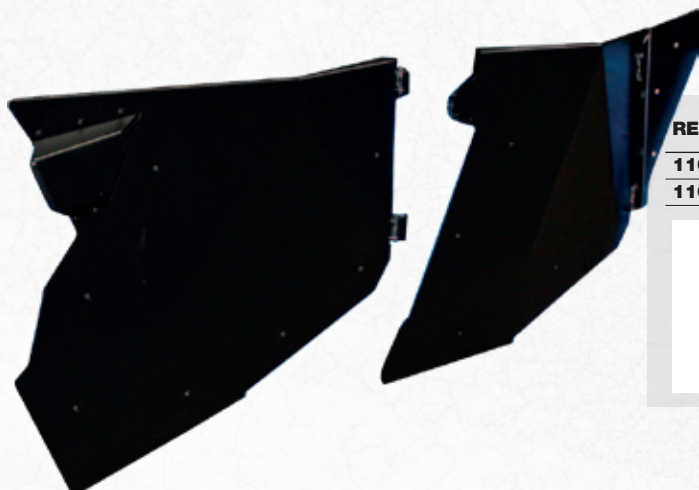

REF	Nome/ Name	Modelo/ Models
110054006PR	Kit Portas/ Doors RXR 1 Black (for original closing) - Black	RZR4 1000
110054007PR	Kit Portas/ Doors RXR 2 (Door for XRW Closing)	RZR4 1000

Nome: Portas RXR 1/ RXR 2
Composição: Alumínio - Liga 6060 - Tratamento T5
Características: Tubo Ø 35x2.5

Name: RXR 1/ RXR 2 Door
 Composition: Aluminum - Special alloy 6060 with a T5 treatment
 Technical features: Pipe Ø 35x2.5



REF	Nome/ Name	Modelo/ Models
110054007PR	Kit Portas/ Doors RXR2 Black (Door Xrw Closing)	RZR4 1000 XP

Nome: Painel de Porta
Composição: Alumínio - Liga 6060 - Tratamento T5
Características: Tubo Ø 35x2.5

Name: Door Panel
 Composition: Aluminum - Special alloy 6060 with a T5 treatment
 Technical features: Pipe Ø 35x2.5

REF	Nome/ Name	Modelo/ Models
110050523PR	Deflector De Ar/ Wind Deflector Alum (Black)	RZR 800
110051021PR	Deflector De Ar/ Wind Deflector Alum (Black)	RZR 800 S
110051519PR	Deflector De Ar/ Wind Deflector Alum (Black)	RZR 900 XP
110052015PR	Deflector De Ar/ Wind Deflector Alum (Black)	RZR 4 900XP
110052503PR	Deflector De Ar/ Wind Deflector Alum (Black)	RZR 1000XP
110053003PR	Deflector De Ar/ Wind Deflector Alum (Black)	ACE 570 SP
110053503PR	Deflector De Ar/ Wind Deflector Alum (Black)	RZR 900 S

Nome: Deflector De Ar Alum
Composição: Alumínio - Liga 5754 - Tratamento T5
Características: Chapa (esp.) 2,5 mm

Name: Wind Deflector Alum
 Composition: Special alloy 5754 with a T5 treatment
 Technical features: Plate (thickness) 2,5 mm

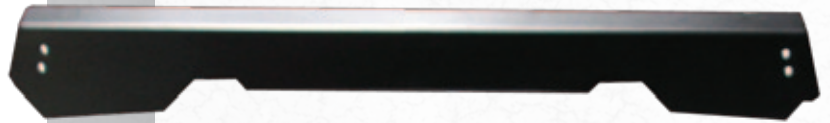

REF	Nome/ Name	Modelo/ Models
110050523PL	Deflector De Ar/ Wind Deflector Polycarbonate	RZR 800
110051021PL	Deflector De Ar/ Wind Deflector Polycarbonate	RZR 800 S
110051519PL	Deflector De Ar/ Wind Deflector Polycarbonate	RZR 900 XP
110052015PL	Deflector De Ar/ Wind Deflector Polycarbonate	RZR 4 900XP
110052503PL	Deflector De Ar/ Wind Deflector Polycarbonate	RZR 1000XP
110053004PL	Deflector De Ar/ Wind Deflector Polycarbonate	ACE 570 SP
110053503PL	Deflector De Ar/ Wind Deflector Polycarbonate	RZR 900 S

Nome: Deflector De Ar Policarbonato
Composição: Policarbonato
Características: 6 mm Espessura

Name: Wind Deflector Polycarbonate
 Composition: Polycarbonate
 Technical features: 6 mm Thickness



REF	Nome/ Name	Modelo/ Models
110050524PL	Prot. Ópticas/ Taillight Protection	RZR 800
110051022PL	Prot. Ópticas/ Taillight Protection	RZR 800 S
110051520PL	Prot. Ópticas/ Taillight Protection	RZR 900 XP
110052016PL	Prot. Ópticas/ Taillight Protection	RZR 4 900XP
110052510PL	Prot. Ópticas/ Taillight Protection	RZR 1000XP
110053009PL	Prot. Ópticas/ Taillight Protection	ACE 570 SP
110053509PL	Prot. Ópticas/ Taillight Protection	RZR 900 S

Nome: Proteção Ópticas Farol
Composição: Policarbonato
Características: 6mm Espessura

Name: Taillight Protection
 Composition: Polycarbonate
 Technical features: 6 mm Thickness



REF	Nome/ Name	Modelo/ Models
110051526PR	Support Trailer Ball - Black	RZR 900 XP
110051531PR	Rocksolid Receiver Winch Mount - Black	RZR 900 XP
110052509PR	Support Trailer Ball - Black	RZR 1000XP

Nome: Suporte Bola Reboque
Composição: Aço
Características: Soldado MIG

Name: Support Trailer Ball
 Composition: Steel
 Technical features: MIG Welding





REF	Nome/ Name	Modelo/ Models
110051527PR	Power Flow Black	RZR 900 XP

Nome: Power Flow Black
Composição: Alumínio - Liga 5754 - Tratamento T5
Características: Chapa (esp.) 2,5 mm
 Name: Power Flow Black
 Composition: Aluminum - Special alloy 5754 with a T5 treatment
 Technical features: Plate (thickness) 2,5 mm

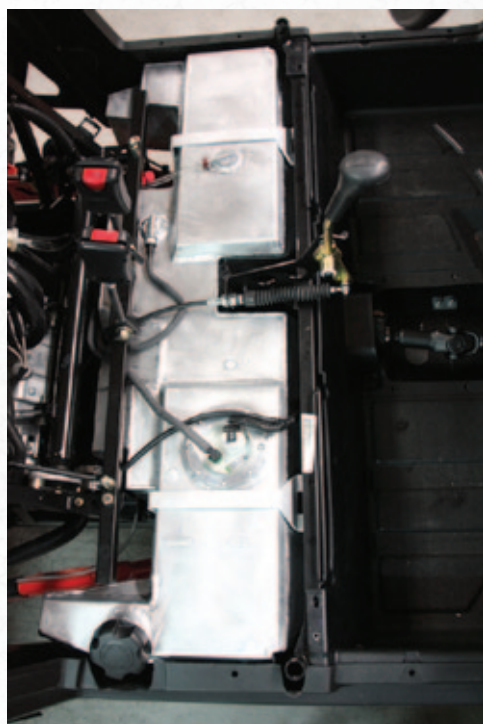

REF	Nome/ Name	Modelo/ Models
110051524NA	Kit Depósito Gasolina/ Kit Fuel Tank	RZR 900 XP

Nome: Kit Depósito Combustível
Composição: Alumínio - Liga 5754 - Tratamento T5
Características: Chapa espessura 2.5 mm com válvula de segurança, capacidade ± 52L
 Name: Fuel Tank
 Composition: Aluminum - Special alloy 5754 with a T5 treatment
 Technical features: Plate (thickness) 2.5mm with safety valve, capacity ± 52L

REF	Nome/ Name	Modelo/ Models
110052530NA	Kit Depósito Gasolina/ Kit Fuel Tank	RZR 1000 XP

Nome: Kit Depósito Combustível
Composição: Alumínio - Liga 5754 - Tratamento T5
Características: Chapa espessura 2.5 mm com válvula de segurança, capacidade ± 57L
 Name: Fuel Tank
 Composition: Aluminum - Special alloy 5754 with a T5 treatment
 Technical features: Plate (thickness) 2.5mm with safety valve, capacity ± 57L



REF	Nome/ Name	Modelo/ Models
110050510PR	Prot. Radiador Preto/ Radiator Protection Black	RZR 800
110050510NA	Prot. Radiador Natural/ Radiator Protection Natural	RZR 800
110051009PR	Prot. Radiador Preto/ Radiator Protection Black	RZR 800 S
110051009NA	Prot. Radiador Natural/ Radiator Protection Natural	RZR 800 S
110051509NA	Prot. Radiador Natural/ Radiator Protection Natural	RZR 900 XP
110051509PR	Prot. Radiador Preto/ Radiator Protection Black	RZR 900 XP
110052017NA	Prot. Radiador Natural/ Radiator Protection Natural	RZR 4 900 XP
110052017PR	Prot. Radiador Preto/ Radiator Protection Black	RZR 4 900 XP

Nome: Proteção Radiador
Composição: Alumínio - Liga 5754 - Tratamento T5
Características: Chapa (esp.) 2,5 mm
 Name: Radiator Protections
 Composition: Special alloy 5754 with a T5 treatment
 Technical features: Plate (thickness) 2,5 mm



REF	Nome/ Name	Modelo/ Models
110051540NA	Final Drive	RZR 900 XP
110052018NA	Final Drive	RZR 4 900 XP
110052519NA	Final Drive	RZR 1000 XP

Nome: Final Drive
Características: Aumento de velocidade 10 km/h
 Name: Final Drive
 Technical features: Increased speed 10 km/ h

REF	Nome/ Name	Modelo/ Models
110050515PR	Front Bumper PX2 Black	RZR 800
110050515PO	Front Bumper PX2 Polish	RZR 800
110051025PR	Front Bumper PX2 Black	RZR 800 S
110051025PO	Front Bumper PX2 Polish	RZR 800 S
110051534PR	Front Bumper PX2 Black	RZR 900 XP
110051534PO	Front Bumper PX2 Polish	RZR 900 XP
110052007PR	Front Bumper PX2 Black	RZR 4 900XP
110052007PO	Front Bumper PX2 Polish	RZR 4 900XP

Nome: Para-choques Frente PX2
Composição: Alumínio - Liga 6060 - Tratamento T5
Características: Tubo Ø 60x2.5 e Ø35x2.5

Name: Front Bumper PX2
 Composition: Aluminum - Special alloy 6060 with a T5 treatment
 Technical features: Pipe Ø 60x2.5 and Ø35x2.5



REF	Nome/ Name	Modelo/ Models
110050517PR	Front Bumper PX6 Black	RZR 800
110051026PR	Front Bumper PX6 Black	RZR 800 S
110051537PR	Front Bumper PX6 Black	RZR 900 XP
110052010PR	Front Bumper PX6 Black	RZR 4 900XP

Nome: Para-choques Frente PX6
Composição: Alumínio - Liga 6060 - Tratamento T5
Características: Tubo Ø 40x2.5 e Ø22x2

Name: Front Bumper PX6
 Composition: Aluminum - Special alloy 6060 with a T5 treatment
 Technical features: Pipe Ø 40x2.5 and Ø22x2



REF	Nome/ Name	Modelo/ Models
110051028PR	Front Bumper PX8 Black	RZR 800 S
110051538PR	Front Bumper PX8 Black	RZR 900 XP
110052011PR	Front Bumper PX8 Black	RZR 4 900XP

Nome: Para-choques Frente PX8
Composição: Alumínio - Liga 6060 - Tratamento T5
Características: Tubo Ø 40x2.5

Name: Front Bumper PX8
 Composition: Aluminum - Special alloy 6060 with a T5 treatment
 Technical features: Pipe Ø 40x2.5



REF	Nome/ Name	Modelo/ Models
110052521PR	Front Bumper PX10 Black	RZR 1000 XP
110053516PR	Front Bumper PX10 Black	RZR 900 S
110054014PR	Front Bumper PX10 Black	RZR4 1000 XP

Nome: Para-choques Frente PX10
Composição: Alumínio - Liga 6060 - Tratamento T5
Características: Tubo Ø 40x2.5

Name: Front Bumper PX10
 Composition: Aluminum - Special alloy 6060 with a T5 treatment
 Technical features: Pipe Ø 40x2.5



REF	Nome/ Name	Modelo/ Models
110052523PR	Front Bumper PX12 Black	RZR 1000 XP
110053518PR	Front Bumper PX12 Black	RZR 900 S
110054016PR	Front Bumper PX12 Black	RZR4 1000 XP

Nome: Para-choques Frente PX12
Composição: Alumínio - Liga 6060 - Tratamento T5
Características: Tubo Ø 40x2.5

Name: Front Bumper PX12
 Composition: Aluminum - Special alloy 6060 with a T5 treatment
 Technical features: Pipe Ø 40x2.5





REF	Nome/ Name	Modelo/ Models
110052524PR	Front Bumper PX13 Black	RZR 1000 XP
110053519PR	Front Bumper PX13 Black	RZR 900 S
110054017PR	Front Bumper PX13 Black	RZR4 1000 XP

Nome: Para-choques Frente PX13
Composição: Alumínio - Liga 6060 - Tratamento T5
Características: Tubo Ø 40x2.5
 Name: Front Bumper PX13
 Composition: Aluminum - Special alloy 6060 with a T5 treatment
 Technical features: Pipe Ø 40x2.5



REF	Nome/ Name	Modelo/ Models
110053007PR	Front Bumper PX14 Black	ACE 570 SP
110053007NA	Front Bumper PX14 Natural	ACE 570 SP

Nome: Para-choques Frente PX14
Composição: Alumínio - Liga 6060 - Tratamento T5
Características: Tubo Ø 35x2.5
 Name: Front Bumper PX14
 Composition: Aluminum - Special alloy 6060 with a T5 treatment
 Technical features: Pipe Ø 35x2.5



● ● ● ● ● ● ● ● ● ●
 - PHD COLOR

REF	Nome/ Name	Modelo/ Models
110052532PR	Front Bumper PX17 Black	RZR 1000 XP

Nome: Para-choques Frente PX17
Composição: Alumínio - Liga 6060 - Tratamento T5
Características: : Tubo Ø 40x2.5/ PHD cor
 Name: Front Bumper PX17
 Composition: Aluminum - Special alloy 6060 with a T5 treatment
 Technical features: Pipe Ø 40x2.5/ PHD color



REF	Nome/ Name	Modelo/ Models
110050516PR	Back Bumper PX3 Black	RZR 800
110050516PO	Back Bumper PX3 Polish	RZR 800
110051031PR	Back Bumper PX3 Black	RZR 800 S
110051031PO	Back Bumper PX3 Polish	RZR 800 S

Nome: Para-choques Trás PX3
Composição: Alumínio - Liga 6060 - Tratamento T5
Características: Tubo Ø 35x2.5
 Name: Back Bumper PX3
 Composition: Aluminum - Special alloy 6060 with a T5 treatment
 Technical features: Pipe Ø 35x2.5



REF	Nome/ Name	Modelo/ Models
110051535PR	Back Bumper PX4 Black	RZR 900 XP
110052008PR	Back Bumper PX4 Black	RZR 4 900 XP

Nome: Para-choques Trás PX4
Composição: Alumínio - Liga 6060 - Tratamento T5
Características: Tubo Ø 35x2.5
 Name: Back Bumper PX4
 Composition: Aluminum - Special alloy 6060 with a T5 treatment
 Technical features: Pipe Ø 35x2.5



REF	Nome/ Name	Modelo/ Models
110051536PR	Back Bumper PX5 Black	RZR 900 XP
110052009PR	Back Bumper PX5 Black	RZR 4 900 XP

Nome: Para-choques Trás PX5
Composição: Alumínio - Liga 6060 - Tratamento T5
Características: Tubo Ø 60x2.5 e Ø 35x2.5
 Name: Back Bumper PX5
 Composition: Aluminum - Special alloy 6060 with a T5 treatment
 Technical features: Pipe Ø 60x2.5 and Ø 35x2.5

REF	Nome/ Name	Modelo/ Models
110050518PR	Back Bumper PX7 Black	RZR 800
110051027PR	Back Bumper PX7 Black	RZR 800 S

Nome: Para-choques Trás PX7
Composição: Alumínio - Liga 6060 - Tratamento T5
Características: Tubo Ø 40x2.5 e Ø 22x2

Name: Back Bumper PX7
 Composition: Aluminum - Special alloy 6060 with a T5 treatment
 Technical features: Pipe Ø 40x2.5 and Ø 22x2



REF	Nome/ Name	Modelo/ Models
110051029PR	Back Bumper Black PX9 With Wheel Support	RZR 800 S
110051539PR	Back Bumper Black PX9 With Wheel Support	RZR 900 XP
110052012PR	Back Bumper Black PX9 With Wheel Support	RZR 4 900XP

Nome: Para-choques Trás PX9 (C/ Suporte de roda)
Composição: Alumínio - Liga 6060 - Tratamento T5
Características: Tubo Ø 40x2.5 e Ø60x2.5

Name: Back Bumper PX9 (With Wheel support)
 Composition: Aluminum - Special alloy 6060 with a T5 treatment
 Technical features: Pipe Ø 40x2.5 and Ø60x2.5



REF	Nome/ Name	Modelo/ Models
110052522PR	Back Bumper PX11 Black	RZR 1000 XP
110054015PR	Back Bumper PX11 Black	RZR4 1000 XP

Nome: Para-choques Trás PX11
Composição: Alumínio - Liga 6060 - Tratamento T5
Características: Tubo Ø 40x2.5

Name: Back Bumper PX11
 Composition: Aluminum - Special alloy 6060 with a T5 treatment
 Technical features: Pipe Ø 40x2.5



REF	Nome/ Name	Modelo/ Models
110053008PR	Back Bumper PX15 Black	ACE 570 SP
110053008NA	Back Bumper PX15 Natural	ACE 570 SP

Nome: Para-choques Trás PX15
Composição: Alumínio - Liga 6060 - Tratamento T5
Características: Tubo Ø 35x2.5

Name: Back Bumper PX15
 Composition: Aluminum - Special alloy 6060 with a T5 treatment
 Technical features: Pipe Ø 35x2.5



REF	Nome/ Name	Modelo/ Models
110053517PR	Back Bumper PX16 Black	RZR 900 S

Nome: Para-choques Trás PX16
Composição: Alumínio - Liga 6060 - Tratamento T5
Características: Tubo Ø 40x2.5 e Ø 22x2

Name: Back Bumper PX16
 Composition: Aluminum - Special alloy 6060 with a T5 treatment
 Technical features: Pipe Ø 40x2.5 and Ø 22x2



REF	Nome/ Name	Modelo/ Models
110052533PR	Back Bumper PX18 Black	RZR 1000 XP

Nome: Para-choques Trás PX18
Composição: Alumínio - Liga 6060 - Tratamento T5
Características: Tubo Ø 40x2.5/ PHD cor

Name: Back Bumper PX18
 Composition: Aluminum - Special alloy 6060 with a T5 treatment
 Technical features: Pipe Ø 40x2.5/ PHD color



PHD COLOR -



MAVERICK

1000 XRS/ 1000 XXC

COMMANDER

1000

CAN-AM

MAVERICK

Quady Srem tel. 61 28 35 657 email: biuro@sklepatv.pl

1000 XRS/ 1000 XXC

REF	Nome/ Name	Modelo/ Models
110100501PR	Front Bumper BR6 Black	MAVERICK 1000 Xrs
110101001PR	Front Bumper BR6 Black	MAVERICK 1000 Xxc

Nome: Para-choques Frente BR6
Composição: Alumínio - Liga 6060 - Tratamento T5
Características: Tubo Ø 40x2.5

Name: Front Bumper BR6
 Composition: Aluminum - Special alloy 6060 with a T5 treatment
 Technical features: Pipe Ø 40x2.5



REF	Nome/ Name	Modelo/ Models
110100502PR	Front Bumper BR8 Black	MAVERICK 1000 Xrs
110101002PR	Front Bumper BR8 Black	MAVERICK 1000 Xxc

Nome: Para-choques Frente BR8
Composição: Alumínio - Liga 6060 - Tratamento T5
Características: Tubo Ø 40x2.5

Name: Front Bumper BR8
 Composition: Aluminum - Special alloy 6060 with a T5 treatment
 Technical features: Pipe Ø 40x2.5



REF	Nome/ Name	Modelo/ Models
110100504PR	Front Bumper BR9 Black (Without plate)	MAVERICK 1000 Xrs
110101004PR	Front Bumper BR9 Black (Without plate)	MAVERICK 1000 Xxc

Nome: Para-choques Frente BR9
Composição: Alumínio - Liga 6060 - Tratamento T5
Características: Tubo Ø 40x2.5

Name: Front Bumper BR9
 Composition: Aluminum - Special alloy 6060 with a T5 treatment
 Technical features: Pipe Ø 40x2.5



REF	Nome/ Name	Modelo/ Models
110100505PR	Front Bumper BR10 Black (With plate)	MAVERICK 1000 Xrs
110101005PR	Front Bumper BR10 Black (With plate)	MAVERICK 1000 Xxc

Nome: Para-choques Frente BR10
Composição: Alumínio - Liga 6060 - Tratamento T5
Características: Tubo Ø 40x2.5

Name: Front Bumper BR10
 Composition: Aluminum - Special alloy 6060 with a T5 treatment
 Technical features: Pipe Ø 40x2.5





REF	Nome/ Name	Modelo/ Models
110100503PR	Back Bumper BR7 Black	MAVERICK 1000 Xrs
110101003PR	Back Bumper BR7 Black	MAVERICK 1000 Xxc

Nome: Para-choques Trás BR7
Composição: Alumínio - Liga 6060 - Tratamento T5
Características: Tubo Ø 40x2.5

Name: Back Bumper BR7
 Composition: Aluminum - Special alloy 6060 with a T5 treatment
 Technical features: Pipe Ø 40 x 2.5

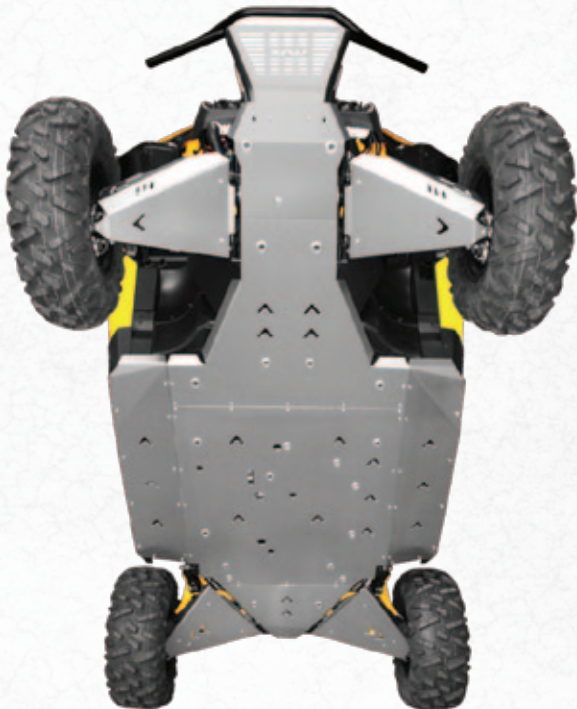

REF	Nome/ Name	Modelo/ Models
110100506NA	Kit Completo/ Complete Kit Alum	MAVERICK 1000 Xrs
110100507NA	Prot. Triang. Frt/ Front A. Arms Alum	MAVERICK 1000 Xrs
110100508NA	Prot. Triang. Trás/ Back A. Arms Alum	MAVERICK 1000 Xrs
110101006NA	Kit Completo/ Complete Kit Alum	MAVERICK 1000 Xxc
110101007NA	Prot. Triang. Frt/ Front A. Arms Alum	MAVERICK 1000 Xxc
110101008NA	Prot. Triang. Trás/ Back A. Arms Alum	MAVERICK 1000 Xxc

Nome: Proteção Motor Alumínio
Composição: Alumínio - Liga 5754 - Tratamento T5
Características: Chapa (esp.) 2,5 mm

Name: Skid Plate Aluminum
 Composition: Special alloy 5754 with a T5 treatment
 Technical features: Plate (thickness) 2,5 mm



REF	Nome/ Name	Modelo/ Models
110100509PH	Kit Prot. Motor PHD / Complete Kit PHD	MAVERICK 1000 Xrs
110100510PH	Prot. Triang. Frt / Front A. Arms PHD	MAVERICK 1000 Xrs
110100511PH	Prot. Triang. Trás / Back A. Arms PHD	MAVERICK 1000 Xrs
110100516PH	Prot. Central / Central Protection PHD	MAVERICK 1000 Xrs
110101009PH	Kit Prot. Motor PHD / Complete Kit PHD	MAVERICK 1000 Xxc
110101010PH	Prot. Triang. Frt / Front A. Arms PHD	MAVERICK 1000 Xxc
110101011PH	Prot. Triang. Trás / Back A. Arms PHD	MAVERICK 1000 Xxc
110101016PH	Prot. Central / Central Protection PHD	MAVERICK 1000 Xxc

Nome: Proteção Motor PHD
Composição: PHD 300 - (Polietileno de alta densidade)
Características: Chapa (esp.) 8 mm

Name: Skid Plate PHD
 Composition: PHD 300 - (High density polyethylene)
 Technical features: Plate (thickness) 8 mm

REF	Nome/ Name	Modelo/ Models
110100512PR	Kit Portas/ Doors Black	MAVERICK 1000 Xrs
110101012PR	Kit Portas/ Doors Black	MAVERICK 1000 Xxc

Nome: Portas Standard
Composição: Alumínio - Liga 6060 - Tratamento T5
Características: Tubo Ø 35x2.5 com almofada de chapa (esp.) 2.5mm

Name: Standard Door
 Composition: Aluminum - Special alloy 6060 with a T5 treatment
 Technical features: Pipe Ø 35x2.5 with plate (thickness)2.5mm



REF	Nome/ Name	Modelo/ Models
110100513PR	Nerf Bar B1 Black	MAVERICK 1000 Xrs
110101013PR	Nerf Bar B1 Natural	MAVERICK 1000 Xxc

Nome: Nerf Bar B1
Composição: Alumínio - Liga 6060 - Tratamento T5
Características: Tubo Ø 35x2.5

Name: Nerf Bar B1
 Composition: Aluminum - Special alloy 6060 with a T5 treatment
 Technical features: Pipe Ø 35x2.5



REF	Nome/ Name	Modelo/ Models
110100514PL	Deflector De Ar/ Wind Deflector - Polycarbonate	MAVERICK 1000 Xrs
110101014PL	Deflector De Ar/ Wind Deflector - Polycarbonate	MAVERICK 1000 Xxc

Nome: Deflector De Ar Policarbonato
Composição: Policarbonato
Características: 6 mm Espessura

Name: Windshield
 Composition: Polycarbonate
 Technical features: 6 mm Thickness



REF	Nome/ Name	Modelo/ Models
110100515PR	Suporte Bola Reboque/ Support Trailer Ball	MAVERICK 1000 Xrs
110101015PR	Suporte Bola Reboque/ Support Trailer Ball	MAVERICK 1000 Xxc

Nome: Suporte Bola Reboque
Composição: Aço
Características: Soldado MIG

Name: Support Trailer Ball
 Composition: Steel
 Technical features: MIG Welding



COMMANDER 1000

Quady Srem tel. 61 28 35 657 email: biuro@sklepatv.pl



REF	Nome/ Name	Modelo/ Models
110101501PR	Para-choques Frente BR3/ Front Bumper BR3 Black	COMMANDER 1000 XT

Nome: Para-choques Frente BR3
Composição: Alumínio - Liga 6060 - Tratamento T5
Características: Tubo Ø 40x2.5

Name: Front Bumper BR3
 Composition: Aluminum - Special alloy 6060 with a T5 treatment
 Technical features: Pipe Ø 40x2.5



REF	Nome/ Name	Modelo/ Models
110101502NA	Kit Completo/ Complete Kit Alum	COMMANDER 1000 XT
110101503NA	Prot. Central/ Central Protection	COMMANDER 1000 XT
110101504NA	Prot. Triang. Frt/ Front A. Arms Alum	COMMANDER 1000 XT
110101505NA	Prot.foles Roda/ Back A-arms Protection	COMMANDER 1000 XT

Nome: Proteção Motor Alumínio
Composição: Alumínio - Liga 5754 - Tratamento T5
Características: Chapa (esp.) 5 mm

Name: Skid Plate Aluminum
 Composition: Special alloy 5754 with a T5 treatment
 Technical features: Plate (thickness) 5 mm



REF	Nome/ Name	Modelo/ Models
110101507PR	NERF BAR B1 BLACK	COMMANDER 1000 XT

Nome: Nerf Bar B1
Composição: Alumínio - Liga 6060 - Tratamento T5
Características: Tubo Ø 35x2.5

Name: Nerf Bar B1
 Composition: Aluminum - Special alloy 6060 with a T5 treatment
 Technical features: Pipe Ø 35 x 2.5



REF	Nome/ Name	Modelo/ Models
110101509PH	Kit Prot. Motor PHD / Complete Kit PHD	COMMANDER 1000 XT
110101510PH	Prot. Central / Central Protection PHD	COMMANDER 1000 XT
110101511PH	Prot. Triang. Frt / Front Triangle Cover PHD	COMMANDER 1000 XT

Nome: Proteção Motor PHD
Composição: PHD 300 - (Polietileno de alta densidade)
Características: Chapa (esp.) 8 mm

Name: Skid Plate PHD
 Composition: PHD 300 - (High density polyethylene)
 Technical features: Plate (thickness) 8 mm

REF	Nome/ Name	Modelo/ Models
110101506PR	Portas/ Doors Standard Black	COMMANDER 1000 XT

Nome: Portas Standard
Composição: Alumínio - Liga 6060 - Tratamento T5
Características: Tubo Ø 35x2.5 com almofada de chapa (esp.) 2.5mm

Name: Standard Door
 Composition: Aluminum - Special alloy 6060 with a T5 treatment
 Technical features: Pipe Ø 35x2.5 with plate (thickness) 2.5mm



REF	Nome/ Name	Modelo/ Models
110101508PL	Deflector De Ar/ Wind Deflector - Polycarbonate	COMMANDER 1000 XT

Nome: Deflector De Ar Policarbonato
Composição: Policarbonato
Características: 6 mm Espessura

Name: Windshield
 Composition: Polycarbonate
 Technical features: 6 mm Thickness



Quady Śrem tel. 61 28 35 657 email: biuro@sklepatv.pl



WILD CAT
1000

ARCTIC CAT

www.quadysrem.pl

www.sklep-atv.pl

www.centrum-brp.pl

REF	Nome/ Name	Modelo/ Models
110150507PR	Para-choques Frente WX1/ Front Bumper WX1 Black	WILDCAT 1000
110150507PO	Para-choques Frente WX1/ Front Bumper WX1 Polish	WILDCAT 1000

Nome: Para-choques Frente WX1

Composição: Alumínio - Liga 6060 - Tratamento T5

Características: Tubo Ø 40x2.5

Name: Front Bumper WX1

Composition: Aluminum - Special alloy 6060 with a T5 treatment

Technical features: Pipe Ø 40x2.5



REF	Nome/ Name	Modelo/ Models
110150508PR	Para-choques Trás WX2/ Back Bumper WX2 Black	WILDCAT 1000
110150508PO	Para-choques Trás WX2/ Back Bumper WX2 Polish	WILDCAT 1000

Nome: Para-choques Trás WX2

Composição: Alumínio - Liga 6060 - Tratamento T5

Características: Tubo Ø 40x2.5

Name: Back Bumper WX2

Composition: Aluminum - Special alloy 6060 with a T5 treatment

Technical features: Pipe Ø 40x2.5



REF	Nome/ Name	Modelo/ Models
110150502NA	Kit Completo/ Complete Kit Alum	WILDCAT 1000
110150503NA	Prot. Triang. Frt/ Front A. Arms Alum	WILDCAT 1000

Nome: Proteção Motor Alumínio

Composição: Alumínio - Liga 5754 - Tratamento T5

Características: Chapa (esp.) 5 mm

Name: Skid Plate Aluminum

Composition: Special alloy 5754 with a T5 treatment

Technical features: Plate (thickness) 5 mm

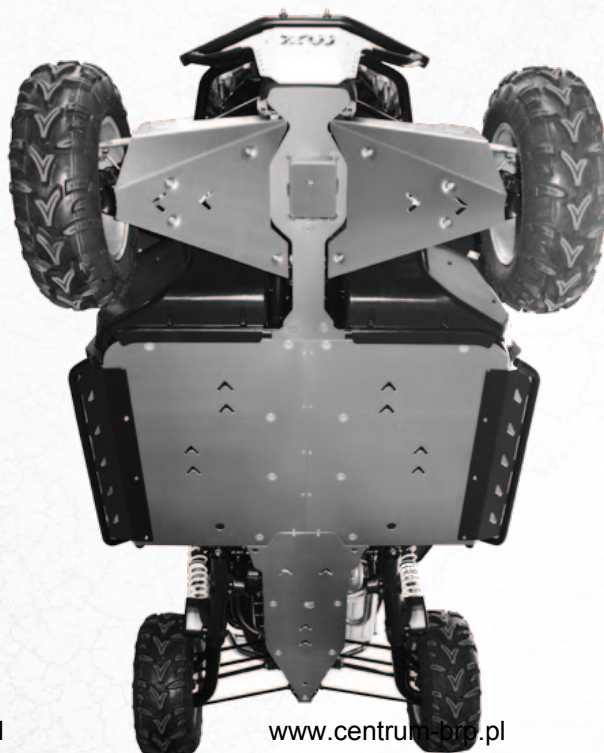



REF	Nome/ Name	Modelo/ Models
110150504PH	Kit Completo (sem triangulos trás)/ Kit PHD (Without Rear A-arms)	WILDCAT 1000
110150505PH	Prot. Triang. Frente PHD/ Front Triangle Cover PHD	WILDCAT 1000
110150506PH	Prot. Triang. Trás PHD/ Rear A - Arms PHD	WILDCAT 1000

Nome: Proteção Motor PHD
Composição: PHD 300 - (Polietileno de alta densidade)
Características: Chapa (esp.) 8 mm
 Name: Skid Plate PHD
 Composition: PHD 300 - (High density polyethylene)
 Technical features: Plate (thickness) 8 mm



REF	Nome/ Name	Modelo/ Models
110150501PR	Portas RXR/ Doors RXR - Black	WILDCAT 1000

Nome: Porta RXR
Composição: Alumínio - Liga 6060 - Tratamento T5
Características: Tubo Ø 35x2.5 com almofada de chapa (esp.) 2.5mm
 Name: Standard RXR
 Composition: Aluminum - Special alloy 6060 with a T5 treatment
 Technical features: Pipe Ø 35x2.5 with plate (thickness) 2.5mm



REF	Nome/ Name	Modelo/ Models
110150510PR	NERF BAR P4 BLACK	WILDCAT 1000

Nome: Nerf Bar P4
Composição: Alumínio - Liga 6060 - Tratamento T5
Características: Tubo Ø 35x2.5
 Name: Nerf Bar P4
 Composition: Aluminum - Special alloy 6060 with a T5 treatment
 Technical features: Pipe Ø 35 x 2.5

REF	Nome/ Name	Modelo/ Models
110150509PL	Deflector De Ar/ Wind Deflector - Polycarbonate	WILDCAT 1000

Nome: Deflector De Ar Policarbonato
Composição: Policarbonato
Características: 6 mm Espessura

Name: Windshield
 Composition: Polycarbonate
 Technical features: 6 mm Thickness



REF	Nome/ Name	Modelo/ Models
110150513PR	Tejadilho Alum/ Alum Roof - Black	WILDCAT 1000

Nome: Tejadilho Alumínio
Composição: Alumínio - Liga 5754 - Tratamento T5
Características: Chapa (esp.) 2,5 mm

Name: Aluminium Roof
 Composition: Special alloy 5754 with a T5 treatment
 Technical features: Plate (thickness) 2,5 mm



REF	Nome/ Name	Modelo/ Models
110150511PR	Roll Bar - Black	WILDCAT 1000
110150512FP	Fitas Roll Bar/ Belt Roll Bar	WILDCAT 1000

Nome: Roll Bar
Composição: Estrutura Tubular em Aço – St37
Características: Tubo de Ø45x2.5 / Ø40 x 2 / Ø30 x 2

Name: Roll Bar
 Composition: Tubular Steel Structure – St37
 Technical features: Pipe Ø45x2.5 / Ø40 x 2 / Ø30 x 2





KIT ATV

REF	Nome/ Name	Modelo/ Models
120250503NA	Kit Completo/ Complete Kit Alum	GRIZZLY 550/ 700FI
120250504NA	Prot. Triang. Frente/ Front A. Arms Alum	GRIZZLY 550/ 700FI
120250505NA	Prot. Triang. Trás/ Back A. Arms Alum	GRIZZLY 550/ 700FI
120200501NA	Kit Completo/ Complete Kit Alum	KING QUAD 500/ 700/ 750
120200502NA	Prot. Triang. Frente/ Front A. Arms Alum	KING QUAD 500/ 700/ 750
120200503NA	Prot. Triang. Trás/ Back A. Arms Alum	KING QUAD 500/ 700/ 750
120300501NA	Kit Completo/ Complete Kit Alum	HONDA RINCON
120251001NA	Kit Completo/ Complete Kit Alum	GRIZZLY 660 - 02/ 05
120251002NA	Prot. Triang. Frente/ Front A. Arms Alum	GRIZZLY 660 - 02/ 05
120251003NA	Prot. Triang. Trás/ Back A. Arms Alum	GRIZZLY 660 - 02/ 05
120350501NA	Kit Completo/ Complete Kit Alum	KVF 750 BRUTE FORCE
120051001NA	Kit Completo/ Complete Kit Alum	SPORTSMAN 800 TWIN
120051002NA	Prot. Triang. Frente/ Front A. Arms Alum	SPORTSMAN 800 TWIN
120051003NA	Prot. Triang. Trás/ Back A. Arms Alum	SPORTSMAN 800 TWIN
120400501NA	Kit Completo/ Complete Kit Alum	KYMCO MXU 500
120102501NA	Kit Completo/ Complete Kit Alum	OUTLANDER 500/ 600/ 800
120103001NA	Kit Completo/ Complete Kit Alum	OUTLANDER 500/ 600/ 800 MAXX
120050502NA	Kit Alum (Sem Laterais)	SPORTSMAN 550XP_850XPS
120050503NA	Kit Alum Prot. Lat./ Kit Frame Guard	SPORTSMAN 550XP_850XPS
120050504NA	Kit Completo/ Complete Kit Alum	SPORTSMAN 550XP_850XPS
120050505NA	Prot. Triang. Frente/ Front A. Arms Alum	SPORTSMAN 550XP_850XPS
120050506NA	Prot. Triang. Trás/ Back A. Arms Alum	SPORTSMAN 550XP_850XPS
120150501NA	Kit Completo/ Complete Kit Alum	ARTIC CAT 550

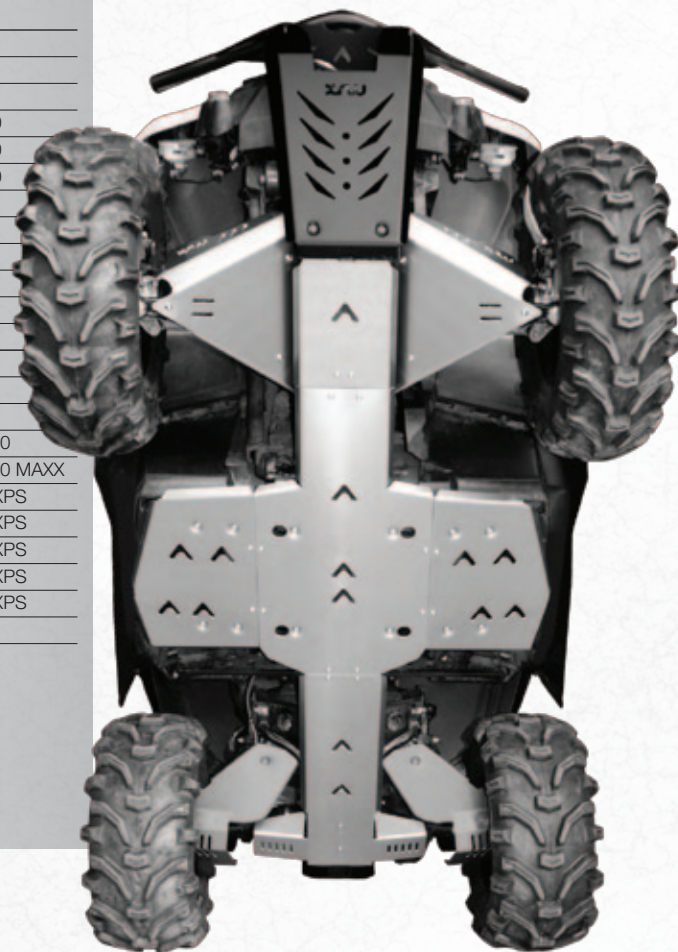

Nome: Proteção Motor Completa Alum
 Composição: Alumínio - Liga 5754 - Tratamento T5
 Características: Chapa (esp.) 5 mm

Name: Kit Skid Plate Alum
 Composition: Aluminum - Special alloy 5754 with a T5 treatment
 Technical features: Plate (thickness) 5 mm

BUMPER ATV

REF	Nome/ Name	Modelo/ Models
120200504PR	Front Bumper Black	KING QUAD 500/ 700/ 750
120250501PR	Front Bumper Black	GRIZZLY 550/ 700FI
120050501PR	Front Bumper Black	SPORTSMAN 550XP_850XPS
120350502PR	Front Bumper Black	KVF 750 BRUTE FORCE
120250502PR	Back Bumper Black	GRIZZLY 550/ 700FI

Nome: Para-choques (Frente e Trás)
 Composição: Alumínio - Liga 6060 - Tratamento T5
 Características: Tubo Ø 40x2.5 e Ø35x2.5

Name: Bumper (Front and Back)
 Composition: Special alloy 6060 with a T5 treatment
 Technical features: Pipe Ø 40x2.5 and Ø35x2.5

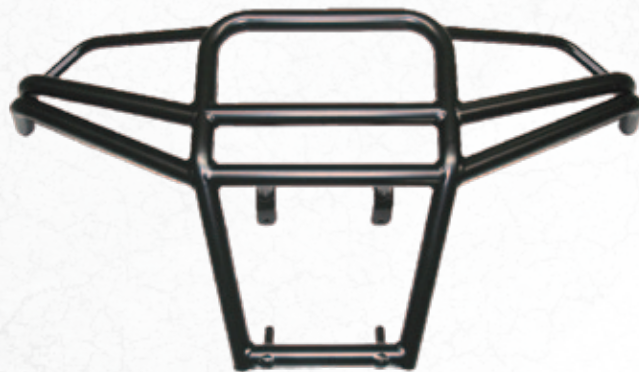

CAN AM RENEGADE

500/ 800/ 1000 X XC - 2012/2014



REF	Nome/ Name	Modelo/ Models
120101001NA	Kit Completo/ Complete Kit Alum	RENEGADE 500/800/1000 X XC
120101004NA	Prot. Triang. Frente/ Front A. Arms Alum	RENEGADE 500/800/1000 X XC
120101005NA	Prot. Triang.Trás/ Back A. Arms Alum	RENEGADE 500/800/1000 X XC

Nome: Proteção Motor Alumínio
Composição: Alumínio - Liga 5754 - Tratamento T5
Características: Chapa (esp.) 5 mm

Name: Skid Plate Aluminum
 Composition: Special alloy 5754 with a T5 treatment
 Technical features: Plate (thickness) 5 mm



REF	Nome/ Name	Modelo/ Models
120101003PH	Kit Prot. Motor PHD / Complete Kit PHD	RENEGADE 500/800/1000 X XC
120101006PH	Prot. Triang. Frente / Front Triangle Cover PHD	RENEGADE 500/800/1000 X XC
120101007PH	Prot. Triang. Trás / Back Triangle Cover PHD	RENEGADE 500/800/1000 X XC

Nome: Proteção Motor PHD
Composição: PHD 300 - (Polietileno de alta densidade)
Características: Chapa (esp.) 8 mm

Name: Skid Plate PHD
 Composition: PHD 300 - (High density polyethylene)
 Technical features: Plate (thickness) 8 mm

REF	Nome/ Name	Modelo/ Models
120101002PR	Para-choques Frente BR4/ Front Bumper BR4 Black	RENEGADE 500/ 800/ 1000 X XC
120101002PO	Para-choques Frente BR4/ Front Bumper BR4 Polish	RENEGADE 500/ 800/ 1000 X XC
120101008PR	Para-choques Frente Br4/ Front Bumper Br4 Winch Black	RENEGADE 500/ 800/ 1000 X XC
120101008PO	Para-choques Frente Br4/ Front Bumper Br4 Winch Black	RENEGADE 500/ 800/ 1000 X XC

Nome: Para-choques Frente BR4
Composição: Alumínio - Liga 6060 - Tratamento T5
Características: Tubo Ø 40x2.5

Name: Front Bumper BR4
 Composition: Aluminum - Special alloy 6060 with a T5 treatment
 Technical features: Pipe Ø 40x2.5



CAN AM OUTLANDER

1000 MAXX 2013 / 1000 Xmr2013

REF	Nome/ Name	Modelo/ Models
120101501NA	Kit Completo/ Complete Kit Alum	OUTLANDER 1000 MAXX 2013
120102001NA	Kit Completo/ Complete Kit Alum	OUTLANDER 1000 X mr 2013

Nome: Proteção Motor Completa Alumínio
Composição: Alumínio - Liga 5754 - Tratamento T5
Características: Chapa (esp.) 5 mm

Name: Kit Skid Plate Aluminum
 Composition: Special alloy 5754 with a T5 treatment
 Technical features: Plate (thickness) 5 mm



REF	Nome/ Name	Modelo/ Models
120101503PH	Kit Completo PHD / Complete Kit PHD	OUTLANDER 1000 MAXX 2013
120101504PH	Prot. Central / Central Protection PHD	OUTLANDER 1000 MAXX 2013
120102003PH	Kit Completo PHD / Complete Kit PHD	OUTLANDER 1000 X mr 2013
120101505PH	Prot. Triang. Frente PHD/ Front A-Arms PHD	OUTLANDER 1000 MAXX
120101506PH	Prot. Triang. Trás PHD/ Back A-Arms PHD	OUTLANDER 1000 MAXX

Nome: Proteção Motor PHD
Composição: Alumínio - Liga 5754 - Tratamento T5
Características: Chapa (esp.) 5 mm

Name: Skid Plate PHD
 Composition: Special alloy 5754 with a T5 treatment
 Technical features: Plate (thickness) 5 mm



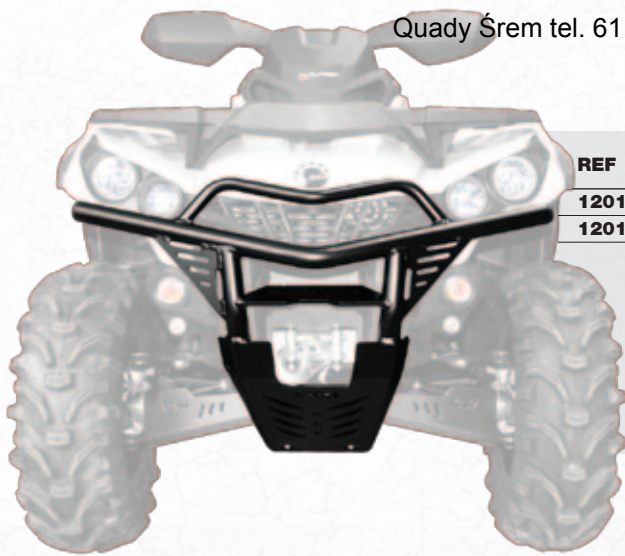

REF	Nome/ Name	Modelo/ Models
120101502PR	Para-choques Frente BR5/ Front Bumper BR5 Black	OUTLANDER 1000 MAXX 2013
120102002PR	Para-choques Frente BR5/ Front Bumper BR5 Black	OUTLANDER 1000 X mr 2013

Nome: Para-choques Frente BR5
Composição: Alumínio - Liga 6060 - Tratamento T5
Características: Tubo Ø 40x2.5

Name: Front Bumper BR5
 Composition: Aluminum - Special alloy 6060 with a T5 treatment
 Technical features: Pipe Ø 40x2.5

POLARIS SCRAMBLER XP 850



REF	Nome/ Name	Modelo/ Models
120051502NA	Kit Completo/ Complete Kit Alum	SCRAMBLER XP 850
120051504NA	Prot. Triang. Frente/ Front A. Arms Alum	SCRAMBLER XP 850
120051505NA	Prot. Triang.Trás/ Back A. Arms Alum	SCRAMBLER XP 850

Nome: Proteção Motor Completa Alumínio
Composição: Alumínio - Liga 5754 - Tratamento T5
Características: Chapa (esp.) 5 mm

Name: Kit Skid Plate Aluminum
 Composition: Special alloy 5754 with a T5 treatment
 Technical features: Plate (thickness) 5 mm



REF	Nome/ Name	Modelo/ Models
120051503PH	Kit Prot. Motor PHD / Complete Kit PHD	SCRAMBLER XP 850
120051506PH	Prot. Triang. Frente PHD/ Front A-Arms PHD	SCRAMBLER XP 850
120051507PH	Prot. Triang. Trás PHD/ Back A-Arms PHD	SCRAMBLER XP 850

Nome: Proteção Motor PHD
Composição: PHD 300 - (Polietileno de alta densidade)
Características: Chapa (esp.) 8 mm

Name: Skid Plate PHD
 Composition: PHD 300 - (High density polyethylene)
 Technical features: Plate (thickness) 8 mm

REF	Nome/ Name	Modelo/ Models
120051501PR	Para-choques Frente/ Front Bumper Black	SCRAMBLER XP 850

Nome: Para-choques Frente
 Composição: Alumínio - Liga 6060 - Tratamento T5
 Características: Tubo Ø 40x2.5

Name: Front Bumper
 Composition: Aluminum - Special alloy 6060 with a T5 treatment
 Technical features: Pipe Ø 40x2.5



CAN AM RENEGADE

500/ 800 até 2012

REF	Nome/ Name	Modelo/ Models
120100506NA	Kit Alum	RENEGADE 500/ 800
120100508NA	Kit Completo/ Complete Kit Alum	RENEGADE 500/ 800
120100509NA	Prot. Triang. Frente/ Front A. Arms Alum	RENEGADE 500/ 800
120100511NA	Prot.central/ Central Protection Alum	RENEGADE 500/ 800
120100512NA	Prot. Lateral (Pes)/ Side Protection Alum	RENEGADE 500/ 800
120100515NA	Kit Prot.foles Tras. Alum/ Back Prot A-arms Alum	RENEGADE 500/ 800

Nome: Proteção Motor Alum
 Composição: Alumínio - Liga 5754 - Tratamento T5
 Características: Chapa (esp.) 5 mm

Name: Kit Skid Plate Alum
 Composition: Aluminum - Special alloy 5754 with a T5 treatment
 Technical features: Plate (thickness) 5 mm

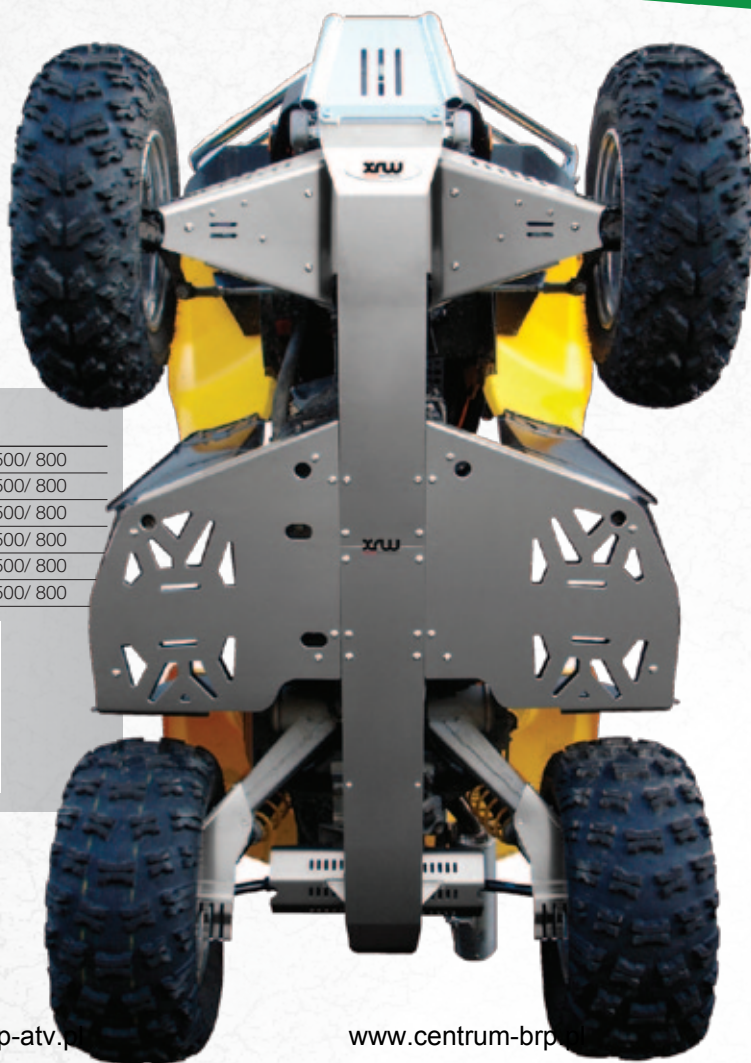



REF	Nome/ Name	Modelo/ Models
120100507PH	Kit PHD	RENEGADE 500/ 800
120100510PH	Prot. Triang. Frente/ Front A. Arms PHD	RENEGADE 500/ 800

Nome: Proteção Motor PHD
Composição: PHD 300 - (Polietileno de alta densidade)
Características: Chapa (esp.) 8 mm

Name: Skid Plate PHD
 Composition: PHD 300 - (High density polyethylene)
 Technical features: Plate (thickness) 8 mm



REF	Nome/ Name	Modelo/ Models
120100501PR	Para-choques Frente BR1/ Front Bumper BR1 Black	RENEGADE 500/ 800
120100501PO	Para-choques Frente BR1/ Front Bumper BR1 Polish	RENEGADE 500/ 800

Nome: Para-choques Frente BR1
Composição: Alumínio - Liga 6060 - Tratamento T5
Características: Tubo Ø 35x2.5

Name: Front Bumper BR1
 Composition: Aluminum - Special alloy 6060 with a T5 treatment
 Technical features: Pipe Ø 35x2.5



REF	Nome/ Name	Modelo/ Models
120100502PR	Para-choques Frente BR2/ Front Bumper BR2 Black	RENEGADE 500/ 800
120100502PO	Para-choques Frente BR2/ Front Bumper BR2 Polish	RENEGADE 500/ 800

Nome: Para-choques Frente BR2
Composição: Alumínio - Liga 6060 - Tratamento T5
Características: Tubo Ø 27x2.5

Name: Front Bumper BR2
 Composition: Aluminum - Special alloy 6060 with a T5 treatment
 Technical features: Pipe Ø 27x2.5



REF	Nome/ Name	Modelo/ Models
120100503PR	Para-choques Frente X7/ Front Bumper X7 Black	RENEGADE 500/ 800
120100503PO	Para-choques Frente X7/ Front Bumper X7 Polish	RENEGADE 500/ 800

Nome: Para-choques Frente X7
Composição: Alumínio - Liga 6060 - Tratamento T5
Características: Tubo Ø 27x2.5

Name: Front Bumper X7
 Composition: Aluminum - Special alloy 6060 with a T5 treatment
 Technical features: Pipe Ø 27x2.5

REF	Nome/ Name	Modelo/ Models
120100504PR	Para-choques Frente X10/ Front Bumper X10 Black	RENEGADE 500/ 800
120100504PO	Para-choques Frente X10/ Front Bumper X10 Polish	RENEGADE 500/ 800

Nome: Para-choques Frente X10
Composição: Alumínio - Liga 6060 - Tratamento T5
Características: Tubo Ø 35x2.5

Name: Front Bumper X10
 Composition: Aluminum - Special alloy 6060 with a T5 treatment
 Technical features: Pipe Ø 35x2.5



REF	Nome/ Name	Modelo/ Models
120100505PR	Para-choques Frente Galaxy/ Front Bumper X10 Galaxy	RENEGADE 500/ 800
120100505PO	Para-choques Frente Galaxy/ Front Bumper X10 Galaxy	RENEGADE 500/ 800

Nome: Para-choques Frente Galaxy
Composição: Alumínio - Liga 6060 - Tratamento T5
Características: Tubo Ø 35x2.5

Name: Front Bumper Galaxy
 Composition: Aluminum - Special alloy 6060 with a T5 treatment
 Technical features: Pipe Ø 35x2.5

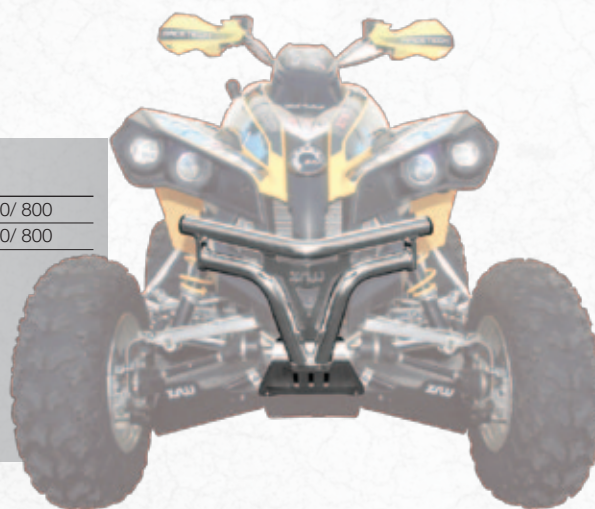

REF	Nome/ Name	Modelo/ Models
120100514PR	Nerf Bar Q1 Black	RENEGADE 500/ 800
120100514PO	Nerf Bar Q1 Polish	RENEGADE 500/ 800

Nome: Nerf Bar Q1
Composição: Alumínio - Liga 6061 - Tratamento T6
Características: Tubo Ø 35x2.5

Name: Nerf Bar Q1
 Composition: Aluminum - Special alloy 6061 with a T6 treatment
 Technical features: Pipe Ø 35x2.5

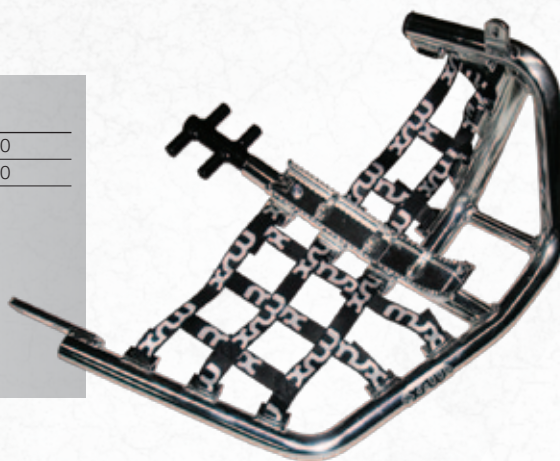

REF	Nome/ Name	Modelo/ Models
120100513PR	Nerf Bar R1 Black	RENEGADE 500/ 800
120100513PO	Nerf Bar R1 Polish	RENEGADE 500/ 800

Nome: Nerf Bar R1
Composição: Alumínio - Liga 6061 - Tratamento T6
Características: Tubo Ø 35x2.5

Name: Nerf Bar R1
 Composition: Aluminum - Special alloy 6061 with a T6 treatment
 Technical features: Pipe Ø 35x2.5





QUAD

BUMPERS

Quady Srem tel 61 28 35 657 email: biuro@sklepatv.pl

REF	Modelo/ Models	
130050512PR	YAMAHA YFM 700 R	■
130050512PO	YAMAHA YFM 700 R	■
130053006PR	YAMAHA YFM 660 R	■
130053006PO	YAMAHA YFM 660 R	■
130052507PR	YAMAHA YFM 350 R	■
130052507PO	YAMAHA YFM 350 R	■
130053514PR	YAMAHA YFZ 450	■
130053514PO	YAMAHA YFZ 450	■
130052007PR	YAMAHA 350 BANSHEE	■
130052007PO	YAMAHA 350 BANSHEE	■
130051505PR	YAMAHA YFM 350 WARRIOR	■
130051505PO	YAMAHA YFM 350 WARRIOR	■
130051004PR	YAMAHA YFS200 Blaster	■
130051004PO	YAMAHA YFS200 Blaster	■
130101013PR	SUZUKI LTZ 400	■
130101013PO	SUZUKI LTZ 400	■
130102002PR	SUZUKI LTZ 400	■
130102002PO	SUZUKI LTZ 400	■
130500502PR	SMC RAM 250/ 150	■
130500502PO	SMC RAM 250/ 150	■
130151505PR	POLARIS PREDATOR 500	■
130151505PO	POLARIS PREDATOR 500	■
130200505PR	KIMCO KXR 250	■
130200505PO	KIMCO KXR 250	■
130201005PR	KIMCO MAXXER 300	■
130201005PO	KIMCO MAXXER 300	■
130400508PR	KAWASAKI KFX 400	■
130400508PO	KAWASAKI KFX 400	■
130401505PR	KAWASAKI KFX 700	■
130401505PO	KAWASAKI KFX 700	■
130251008PR	HONDA TRX 400 EX	■
130251008PO	HONDA TRX 400 EX	■
130252011PR	HONDA TRX 450	■
130252011PO	HONDA TRX 450	■
130250502PR	HONDA TRX 250 EX	■
130250502PO	HONDA TRX 250 EX	■
130451507PR	CAN AM DS 650	■
130451507PO	CAN AM DS 650	■
130350504PR	ADLY 300	■
130350504PO	ADLY 300	■
130100512PR	SUZUKI LTR 450	■
130100512PO	SUZUKI LTR 450	■
130401010PR	KAWASAKI KFX 450	■
130401010PO	KAWASAKI KFX 450	■
130054007PR	YAMAHA YFM 250 R	■
130054007PO	YAMAHA YFM 250 R	■
130450511PR	CAN AM DS 450EFI	■
130450511PO	CAN AM DS 450EFI	■
130300510PR	KTM 450/525 XC	■
130300510PO	KTM 450/525 XC	■
130150505PR	POLARIS OUTLAW 500 IRS/525 IRS	■
130150505PO	POLARIS OUTLAW 500 IRS/525 IRS	■

130101513PR	SUZUKI LTZ 400 K9	■
130101513PO	SUZUKI LTZ 400 K9	■
130252506PR	HONDA TRX 700	■
130252506PO	HONDA TRX 700	■
130151006PR	POLARIS OUTLAW 525 S/450 MXR	■
130151006PO	POLARIS OUTLAW 525 S/450 MXR	■
130054512PR	YAMAHA YFZ 450 R	■
130054512PO	YAMAHA YFZ 450 R	■
130700508PR	ARTIC CAT DVX 400	■
130700508PO	ARTIC CAT DVX 400	■
130650502PR	AEON COBRA 350	■
130650502PO	AEON COBRA 350	■
130550503PR	DINLI DMX 450	■
130550503PO	DINLI DMX 450	■
130501002PR	SMC CAPTAIN 300	■
130501002PO	SMC CAPTAIN 300	■
130351004PR	ADLI 500	■
130351004PO	ADLI 500	■
130451011PR	CAN AM DS 450 XMX	■
130451011PO	CAN AM DS 450 XMX	■
130301010PR	KTM 505- 450 SX	■
130301010PO	KTM 505- 450 SX	■
130253005PR	HONDA TRX 300	■
130253005PO	HONDA TRX 300	■
130251508PR	HONDA TRX 400 EX - 2008	■
130251508PO	HONDA TRX 400 EX - 2008	■
130250502PR	HONDA TRX 250 EX	■
130250502PO	HONDA TRX 250 EX	■

Nome: Para-choques Galaxy

Composição: Alumínio - Liga 6060 - Tratamento T5

Características: Tubo Ø 35 x 2.5

Name: Front Bumper Galaxy

Composition: Aluminum - Special alloy 6060 with a T5 treatment

Technical features: Pipe Ø 35 x 2.5

GALAXY



REF	Modelo/ Models	
130050513PR	YAMAHA YFM 700 R	■
130050513PO	YAMAHA YFM 700 R	■
130051005PR	YAMAHA YFS200 Blaster	■
130051005PO	YAMAHA YFS200 Blaster	■
130051506PR	YAMAHA YFM 350 WARRIOR	■
130051506PO	YAMAHA YFM 350 WARRIOR	■
130052008PR	YAMAHA 350 BANSHEE	■
130052008PO	YAMAHA 350 BANSHEE	■
130052508PR	YAMAHA YFM 350R	■
130052508PO	YAMAHA YFM 350R	■
130053007PR	YAMAHA YFM 660R	■
130053007PO	YAMAHA YFM 660R	■
130053515PR	YAMAHA YFZ 450	■
130053515PO	YAMAHA YFZ 450	■
130054008PR	YAMAHA YFM 250 R	■
130054008PO	YAMAHA YFM 250 R	■
130054513PR	YAMAHA YFZ 450 R	■
130054513PO	YAMAHA YFZ 450 R	■
130100513PR	SUZUKI LTR 450	■
130100513PO	SUZUKI LTR 450	■
130101014PR	SUZUKI LTZ 400	■
130101014PO	SUZUKI LTZ 400	■
130101514PR	SUZUKI LTZ 400 K9	■
130101514PO	SUZUKI LTZ 400 K9	■
130102003PR	SUZUKI LTZ 250	■
130102003PO	SUZUKI LTZ 250	■
130150506PR	POLARIS OUTLAW 500 IRS/525 IRS	■
130150506PO	POLARIS OUTLAW 500 IRS/525 IRS	■
130151007PR	POLARIS OUTLAW 525 S/450 MXR	■
130151007PO	POLARIS OUTLAW 525 S/450 MXR	■
130151506PR	POLARIS PREDATOR 500	■
130151506PO	POLARIS PREDATOR 500	■
130200506PR	KIMCO KXR 250	■
130200506PO	KIMCO KXR 250	■
130201006PR	KIMCO MAXXER 300	■
130201006PO	KIMCO MAXXER 300	■
130250503PR	HONDA TRX 250 EX	■
130250503PO	HONDA TRX 250 EX	■
130251009PR	HONDA TRX 400 EX	■
130251009PO	HONDA TRX 400 EX	■
130251509PR	HONDA TRX 400 EX - 2008	■
130251509PO	HONDA TRX 400 EX - 2008	■
130252012PR	HONDA TRX 450	■
130252012PO	HONDA TRX 450	■
130252507PR	HONDA TRX 700	■
130252507PO	HONDA TRX 700	■
130253006PR	HONDA TRX 300	■
130253006PO	HONDA TRX 300	■
130300511PR	KTM 450/525 XC	■
130300511PO	KTM 450/525 XC	■
130301011PR	KTM 505- 450 SX	■
130301011PO	KTM 505- 450 SX	■

130350505PR	ADLY 300	■
130350505PO	ADLY 300	■
130351005PR	ADLY 500	■
130351005PO	ADLY 500	■
130400509PR	KAWASAKI KFX 400	■
130400509PO	KAWASAKI KFX 400	■
130401011PR	KAWASAKI KFX 450	■
130401011PO	KAWASAKI KFX 450	■
130401506PR	KAWASAKI KFX 700	■
130401506PO	KAWASAKI KFX 700	■
130450512PR	CAN AM DS 450EFI	■
130450512PO	CAN AM DS 450EFI	■
130451012PR	CAN AM DS 450 XMX	■
130451012PO	CAN AM DS 450 XMX	■
130451508PR	CAN AM DS 650	■
130451508PO	CAN AM DS 650	■
130500503PR	SMC RAM 250/150	■
130500503PO	SMC RAM 250/150	■
130501003PR	SMC CAPTAIN 300	■
130501003PO	SMC CAPTAIN 300	■
130550504PR	DINLI DMX 450	■
130550504PO	DINLI DMX 450	■
130650503PR	AEON COBRA 350	■
130650503PO	AEON COBRA 350	■
130700509PR	ARTIC CAT DVX 400	■
130700509PO	ARTIC CAT DVX 400	■

Nome: Para-choques X1

Composição: Alumínio - Liga 6060 - Tratamento T5

Características: Tubo Ø 35 x 2.5

Name: Front Bumper X1

Composition: Aluminum - Special alloy 6060 with a T5 treatment

Technical features: Pipe Ø 35 x 2.5

X1



REF	Modelo/ Models	
130050514PR	YAMAHA YFM 700 R	■
130050514PO	YAMAHA YFM 700 R	■
130051006PR	YAMAHA YFS200 Blaster	■
130051006PO	YAMAHA YFS200 Blaster	■
130051507PR	YAMAHA YFM 350 WARRIOR	■
130051507PO	YAMAHA YFM 350 WARRIOR	■
130052009PR	YAMAHA 350 BANSHEE	■
130052009PO	YAMAHA 350 BANSHEE	■
130052509PR	YAMAHA YFM 350R	■
130052509PO	YAMAHA YFM 350R	■
130053008PR	YAMAHA YFM 660R	■
130053008PO	YAMAHA YFM 660R	■
130053516PR	YAMAHA YFZ 450	■
130053516PO	YAMAHA YFZ 450	■
130054009PR	YAMAHA YFM 250 R	■
130054009PO	YAMAHA YFM 250 R	■
130054514PR	YAMAHA YFZ 450 R	■
130054514PO	YAMAHA YFZ 450 R	■
130100514PR	SUZUKI LTR 450	■
130100514PO	SUZUKI LTR 450	■
130101015PR	SUZUKI LTZ 400	■
130101015PO	SUZUKI LTZ 400	■
130101515PR	SUZUKI LTZ 400 K9	■
130101515PO	SUZUKI LTZ 400 K9	■
130102004PR	SUZUKI LTZ 250	■
130102004PO	SUZUKI LTZ 250	■
130150507PR	POLARIS OUTLAW 500 IRS/525 IRS	■
130150507PO	POLARIS OUTLAW 500 IRS/525 IRS	■
130151008PR	POLARIS OUTLAW 525 S/450 MXR	■
130151008PO	POLARIS OUTLAW 525 S/450 MXR	■
130151507PR	POLARIS PREDATOR 500	■
130151507PO	POLARIS PREDATOR 500	■
130200507PR	KIMCO KXR 250	■
130200507PO	KIMCO KXR 250	■
130201007PR	KIMCO MAXXER 300	■
130201007PO	KIMCO MAXXER 300	■
130250504PR	HONDA TRX 250 EX	■
130250504PO	HONDA TRX 250 EX	■
130251010PR	HONDA TRX 400 EX	■
130251010PO	HONDA TRX 400 EX	■
130251510PR	HONDA TRX 400 EX - 2008	■
130251510PO	HONDA TRX 400 EX - 2008	■
130252013PR	HONDA TRX 450	■
130252013PO	HONDA TRX 450	■
130253007PR	HONDA TRX 300	■
130253007PO	HONDA TRX 300	■
130300512PR	KTM 450/525 XC	■
130300512PO	KTM 450/525 XC	■
130301012PR	KTM 505- 450 SX	■
130301012PO	KTM 505- 450 SX	■
130350506PR	ADLY 300	■
130350506PO	ADLY 300	■

130351006PR	ADLY 500	■
130351006PO	ADLY 500	■
130400510PR	KAWASAKI KFX 400	■
130400510PO	KAWASAKI KFX 400	■
130401012PR	KAWASAKI KFX 450	■
130401012PO	KAWASAKI KFX 450	■
130401507PR	KAWASAKI KFX 700	■
130401507PO	KAWASAKI KFX 700	■
130450513PR	CAN AM DS 450EFI	■
130450513PO	CAN AM DS 450EFI	■
130451013PR	CAN AM DS 450 XMX	■
130451013PO	CAN AM DS 450 XMX	■
130451509PR	CAN AM DS 650	■
130451509PO	CAN AM DS 650	■
130500504PR	SMC RAM 250/150	■
130500504PO	SMC RAM 250/150	■
130501004PR	SMC CAPTAIN 300	■
130501004PO	SMC CAPTAIN 300	■
130550505PR	DINLI DMX 450	■
130550505PO	DINLI DMX 450	■
130650504PR	AEON COBRA 350	■
130650504PO	AEON COBRA 350	■
130700510PR	ARTIC CAT DVX 400	■
130700510PO	ARTIC CAT DVX 400	■

Nome: Para-choques X2

Composição: Alumínio - Liga 6060 - Tratamento T5

Características: Tubo Ø 25 x 2.5

Name: Front Bumper X2

Composition: Aluminum - Special alloy 6060 with a T5 treatment

Technical features: Pipe Ø 25 x 2.5

X2



REF	Modelo/ Models	
130050515PR	YAMAHA YFM 700 R	■
130050515PO	YAMAHA YFM 700 R	■
130051007PR	YAMAHA YFS200 Blaster	■
130051007PO	YAMAHA YFS200 Blaster	■
130051508PR	YAMAHA YFM 350 WARRIOR	■
130051508PO	YAMAHA YFM 350 WARRIOR	■
130052010PR	YAMAHA 350 BANSHEE	■
130052010PO	YAMAHA 350 BANSHEE	■
130052510PR	YAMAHA YFM 350R	■
130052510PO	YAMAHA YFM 350R	■
130053009PR	YAMAHA YFM 660R	■
130053009PO	YAMAHA YFM 660R	■
130053517PR	YAMAHA YFZ 450	■
130053517PO	YAMAHA YFZ 450	■
130054010PR	YAMAHA YFM 250 R	■
130054010PO	YAMAHA YFM 250 R	■
130054515PR	YAMAHA YFZ 450 R	■
130054515PO	YAMAHA YFZ 450 R	■
130100515PR	SUZUKI LTR 450	■
130100515PO	SUZUKI LTR 450	■
130101016PR	SUZUKI LTZ 400	■
130101016PO	SUZUKI LTZ 400	■
130101516PR	SUZUKI LTZ 400 K9	■
130101516PO	SUZUKI LTZ 400 K9	■
130102005PR	SUZUKI LTZ 250	■
130102005PO	SUZUKI LTZ 250	■
130150508PR	POLARIS OUTLAW 500 IRS/525 IRS	■
130150508PO	POLARIS OUTLAW 500 IRS/525 IRS	■
130151009PR	POLARIS OUTLAW 525 S/450 MXR	■
130151009PO	POLARIS OUTLAW 525 S/450 MXR	■
130151508PR	POLARIS PREDATOR 500	■
130151508PO	POLARIS PREDATOR 500	■
130200508PR	KIMCO KXR 250	■
130200508PO	KIMCO KXR 250	■
130201008PR	KIMCO MAXXER 300	■
130201008PO	KIMCO MAXXER 300	■
130250505PR	HONDA TRX 250 EX	■
130250505PO	HONDA TRX 250 EX	■
130251011PR	HONDA TRX 400 EX	■
130251011PO	HONDA TRX 400 EX	■
130251511PR	HONDA TRX 400 EX - 2008	■
130251511PO	HONDA TRX 400 EX - 2008	■
130252014PR	HONDA TRX 450	■
130252014PO	HONDA TRX 450	■
130252508PR	HONDA TRX 700	■
130252508PO	HONDA TRX 700	■
130253008PR	HONDA TRX 300	■
130253008PO	HONDA TRX 300	■
130300513PR	KTM 450/525 XC	■
130300513PO	KTM 450/525 XC	■
130301013PR	KTM 505- 450 SX	■
130301013PO	KTM 505- 450 SX	■

130350507PR	ADLY 300	■
130350507PO	ADLY 300	■
130351007PR	ADLY 500	■
130351007PO	ADLY 500	■
130400511PR	KAWASAKI KFX 400	■
130400511PO	KAWASAKI KFX 400	■
130401013PR	KAWASAKI KFX 450	■
130401013PO	KAWASAKI KFX 450	■
130401508PR	KAWASAKI KFX 700	■
130401508PO	KAWASAKI KFX 700	■
130450514PR	CAN AM DS 450EFI	■
130450514PO	CAN AM DS 450EFI	■
130451014PR	CAN AM DS 450 XMX	■
130451014PO	CAN AM DS 450 XMX	■
130451510PR	CAN AM DS 650	■
130451510PO	CAN AM DS 650	■
130500505PR	SMC RAM 250/150	■
130500505PO	SMC RAM 250/150	■
130501005PR	SMC CAPTAIN 300	■
130501005PO	SMC CAPTAIN 300	■
130550506PR	DINLI DMX 450	■
130550506PO	DINLI DMX 450	■
130650505PR	AEON COBRA 350	■
130650505PO	AEON COBRA 350	■
130700511PR	ARTIC CAT DVX 400	■
130700511PO	ARTIC CAT DVX 400	■

Nome: Para-choques X5

Composição: Alumínio - Liga 6060 - Tratamento T5

Características: Tubo Ø 35 x 2.5

Name: Front Bumper X5

Composition: Aluminum - Special alloy 6060 with a T5 treatment

Technical features: Pipe Ø 35 x 2.5

X5



REF	Modelo/ Models	
130050516PR	YAMAHA YFM 700 R	■
130050516PO	YAMAHA YFM 700 R	■
130051008PR	YAMAHA YFS200 Blaster	■
130051008PO	YAMAHA YFS200 Blaster	■
130051509PR	YAMAHA YFM 350 WARRIOR	■
130051509PO	YAMAHA YFM 350 WARRIOR	■
130052011PR	YAMAHA 350 BANSHEE	■
130052011PO	YAMAHA 350 BANSHEE	■
130052511PR	YAMAHA YFM 350R	■
130052511PO	YAMAHA YFM 350R	■
130053010PR	YAMAHA YFM 660R	■
130053010PO	YAMAHA YFM 660R	■
130053518PR	YAMAHA YFZ 450	■
130053518PO	YAMAHA YFZ 450	■
130054011PR	YAMAHA YFM 250 R	■
130054011PO	YAMAHA YFM 250 R	■
130054516PR	YAMAHA YFZ 450 R	■
130054516PO	YAMAHA YFZ 450 R	■
130100516PR	SUZUKI LTR 450	■
130100516PO	SUZUKI LTR 450	■
130101017PR	SUZUKI LTZ 400	■
130101017PO	SUZUKI LTZ 400	■
130101517PR	SUZUKI LTZ 400 K9	■
130101517PO	SUZUKI LTZ 400 K9	■
130102006PR	SUZUKI LTZ 250	■
130102006PO	SUZUKI LTZ 250	■
130150509PR	POLARIS OUTLAW 500 IRS/525 IRS	■
130150509PO	POLARIS OUTLAW 500 IRS/525 IRS	■
130151010PR	POLARIS OUTLAW 525 S/450 MXR	■
130151010PO	POLARIS OUTLAW 525 S/450 MXR	■
130151509PR	POLARIS PREDATOR 500	■
130151509PO	POLARIS PREDATOR 500	■
130200509PR	KIMCO KXR 250	■
130200509PO	KIMCO KXR 250	■
130201009PR	KIMCO MAXXER 300	■
130201009PO	KIMCO MAXXER 300	■
130250506PR	HONDA TRX 250 EX	■
130250506PO	HONDA TRX 250 EX	■
130251012PR	HONDA TRX 400 EX	■
130251012PO	HONDA TRX 400 EX	■
130251512PR	HONDA TRX 400 EX - 2008	■
130251512PO	HONDA TRX 400 EX - 2008	■
130252015PR	HONDA TRX 450	■
130252015PO	HONDA TRX 450	■
130252509PR	HONDA TRX 700	■
130252509PO	HONDA TRX 700	■
130253009PR	HONDA TRX 300	■
130253009PO	HONDA TRX 300	■
130300514PR	KTM 450/525 XC	■
130300514PO	KTM 450/525 XC	■
130301014PR	KTM 505- 450 SX	■
130301014PO	KTM 505- 450 SX	■

130350508PR	ADLY 300	■
130350508PO	ADLY 300	■
130351008PR	ADLY 500	■
130351008PO	ADLY 500	■
130400512PR	KAWASAKI KFX 400	■
130400512PO	KAWASAKI KFX 400	■
130401014PR	KAWASAKI KFX 450	■
130401014PO	KAWASAKI KFX 450	■
130401509PR	KAWASAKI KFX 700	■
130401509PO	KAWASAKI KFX 700	■
130450515PR	CAN AM DS 450EFI	■
130450515PO	CAN AM DS 450EFI	■
130451015PR	CAN AM DS 450 XMX	■
130451015PO	CAN AM DS 450 XMX	■
130451511PR	CAN AM DS 650	■
130451511PO	CAN AM DS 650	■
130500506PR	SMC RAM 250/150	■
130500506PO	SMC RAM 250/150	■
130501006PR	SMC CAPTAIN 300	■
130501006PO	SMC CAPTAIN 300	■
130550507PR	DINLI DMX 450	■
130550507PO	DINLI DMX 450	■
130650506PR	AEON COBRA 350	■
130650506PO	AEON COBRA 350	■
130700512PR	ARTIC CAT DVX 400	■
130700512PO	ARTIC CAT DVX 400	■

Nome: Para-choques X6

Composição: Alumínio - Liga 6060 - Tratamento T5

Características: Tubo Ø 35 x 2.5

Name: Front Bumper X6

Composition: Aluminum - Special alloy 6060 with a T5 treatment

Technical features: Pipe Ø 35 x 2.5

X6



REF	Modelo/ Models	
130050517PR	YAMAHA YFM 700 R	■
130050517PO	YAMAHA YFM 700 R	■
130051009PR	YAMAHA YFS200 Blaster	■
130051009PO	YAMAHA YFS200 Blaster	■
130051510PR	YAMAHA YFM 350 WARRIOR	■
130051510PO	YAMAHA YFM 350 WARRIOR	■
130052012PR	YAMAHA 350 BANSHEE	■
130052012PO	YAMAHA 350 BANSHEE	■
130052512PR	YAMAHA YFM 350R	■
130052512PO	YAMAHA YFM 350R	■
130053011PR	YAMAHA YFM 660R	■
130053011PO	YAMAHA YFM 660R	■
130053519PR	YAMAHA YFZ 450	■
130053519PO	YAMAHA YFZ 450	■
130054012PR	YAMAHA YFM 250 R	■
130054012PO	YAMAHA YFM 250 R	■
130054517PR	YAMAHA YFZ 450 R	■
130054517PO	YAMAHA YFZ 450 R	■
130100517PR	SUZUKI LTR 450	■
130100517PO	SUZUKI LTR 450	■
130101018PR	SUZUKI LTZ 400	■
130101018PO	SUZUKI LTZ 400	■
130101518PR	SUZUKI LTZ 400 K9	■
130101518PO	SUZUKI LTZ 400 K9	■
130102007PR	SUZUKI LTZ 250	■
130102007PO	SUZUKI LTZ 250	■
130150510PR	POLARIS OUTLAW 500 IRS/525 IRS	■
130150510PO	POLARIS OUTLAW 500 IRS/525 IRS	■
130151011PR	POLARIS OUTLAW 525 S/450 MXR	■
130151011PO	POLARIS OUTLAW 525 S/450 MXR	■
130151510PR	POLARIS PREDATOR 500	■
130151510PO	POLARIS PREDATOR 500	■
130200510PR	KIMCO KXR 250	■
130200510PO	KIMCO KXR 250	■
130201010PR	KIMCO MAXXER 300	■
130201010PO	KIMCO MAXXER 300	■
130250507PR	HONDA TRX 250 EX	■
130250507PO	HONDA TRX 250 EX	■
130251013PR	HONDA TRX 400 EX	■
130251013PO	HONDA TRX 400 EX	■
130251513PR	HONDA TRX 400 EX - 2008	■
130251513PO	HONDA TRX 400 EX - 2008	■
130252016PR	HONDA TRX 450	■
130252016PO	HONDA TRX 450	■
130252510PR	HONDA TRX 700	■
130252510PO	HONDA TRX 700	■
130253010PR	HONDA TRX 300	■
130253010PO	HONDA TRX 300	■
130300515PR	KTM 450/525 XC	■
130300515PO	KTM 450/525 XC	■
130301015PR	KTM 505- 450 SX	■
130301015PO	KTM 505- 450 SX	■

130350509PR	ADLY 300	■
130350509PO	ADLY 300	■
130351009PR	ADLY 500	■
130351009PO	ADLY 500	■
130400513PR	KAWASAKI KFX 400	■
130400513PO	KAWASAKI KFX 400	■
130401015PR	KAWASAKI KFX 450	■
130401015PO	KAWASAKI KFX 450	■
130401510PR	KAWASAKI KFX 700	■
130401510PO	KAWASAKI KFX 700	■
130450516PR	CAN AM DS 450EFI	■
130450516PO	CAN AM DS 450EFI	■
130451016PR	CAN AM DS 450 XMX	■
130451016PO	CAN AM DS 450 XMX	■
130451512PR	CAN AM DS 650	■
130451512PO	CAN AM DS 650	■
130500507PR	SMC RAM 250/150	■
130500507PO	SMC RAM 250/150	■
130501007PR	SMC CAPTAIN 300	■
130501007PO	SMC CAPTAIN 300	■
130550508PR	DINLI DMX 450	■
130550508PO	DINLI DMX 450	■
130650507PR	AEON COBRA 350	■
130650507PO	AEON COBRA 350	■
130700513PR	ARTIC CAT DVX 400	■
130700513PO	ARTIC CAT DVX 400	■

Nome: Para-choques XR7

Composição: Alumínio - Liga 6060 - Tratamento T5

Características: Tubo Ø 25 x 2.5

Name: Front Bumper XR7

Composition: Aluminum - Special alloy 6060 with a T5 treatment

Technical features: Pipe Ø 25 x 2.5

XR7



REF	Modelo/ Models	
130050518PR	YAMAHA YFM 700 R	■
130050518PO	YAMAHA YFM 700 R	■
130051010PR	YAMAHA YFS200 Blaster	■
130051010PO	YAMAHA YFS200 Blaster	■
130051511PR	YAMAHA YFM 350 WARRIOR	■
130051511PO	YAMAHA YFM 350 WARRIOR	■
130052013PR	YAMAHA 350 BANSHEE	■
130052013PO	YAMAHA 350 BANSHEE	■
130052513PR	YAMAHA YFM 350R	■
130052513PO	YAMAHA YFM 350R	■
130053012PR	YAMAHA YFM 660R	■
130053012PO	YAMAHA YFM 660R	■
130053520PR	YAMAHA YFZ 450	■
130053520PO	YAMAHA YFZ 450	■
130054013PR	YAMAHA YFM 250 R	■
130054013PO	YAMAHA YFM 250 R	■
130054518PR	YAMAHA YFZ 450 R	■
130054518PO	YAMAHA YFZ 450 R	■
130100518PR	SUZUKI LTR 450	■
130100518PO	SUZUKI LTR 450	■
130101019PR	SUZUKI LTZ 400	■
130101019PO	SUZUKI LTZ 400	■
130101519PR	SUZUKI LTZ 400 K9	■
130101519PO	SUZUKI LTZ 400 K9	■
130102008PR	SUZUKI LTZ 250	■
130102008PO	SUZUKI LTZ 250	■
130150511PR	POLARIS OUTLAW 500 IRS/525 IRS	■
130150511PO	POLARIS OUTLAW 500 IRS/525 IRS	■
130151012PR	POLARIS OUTLAW 525 S/450 MXR	■
130151012PO	POLARIS OUTLAW 525 S/450 MXR	■
130151511PR	POLARIS PREDATOR 500	■
130151511PO	POLARIS PREDATOR 500	■
130200511PR	KIMCO KXR 250	■
130200511PO	KIMCO KXR 250	■
130201011PR	KIMCO MAXXER 300	■
130201011PO	KIMCO MAXXER 300	■
130250508PR	HONDA TRX 250 EX	■
130250508PO	HONDA TRX 250 EX	■
130251014PR	HONDA TRX 400 EX	■
130251014PO	HONDA TRX 400 EX	■
130251514PR	HONDA TRX 400 EX - 2008	■
130251514PO	HONDA TRX 400 EX - 2008	■
130252017PR	HONDA TRX 450	■
130252017PO	HONDA TRX 450	■
130252511PR	HONDA TRX 700	■
130252511PO	HONDA TRX 700	■
130253011PR	HONDA TRX 300	■
130253011PO	HONDA TRX 300	■
130300516PR	KTM 450/525 XC	■
130300516PO	KTM 450/525 XC	■
130301016PR	KTM 505- 450 SX	■
130301016PO	KTM 505- 450 SX	■

130350510PR	ADLY 300	■
130350510PO	ADLY 300	■
130351010PR	ADLY 500	■
130351010PO	ADLY 500	■
130400514PR	KAWASAKI KFX 400	■
130400514PO	KAWASAKI KFX 400	■
130401016PR	KAWASAKI KFX 450	■
130401016PO	KAWASAKI KFX 450	■
130401511PR	KAWASAKI KFX 700	■
130401511PO	KAWASAKI KFX 700	■
130450517PR	CAN AM DS 450EFI	■
130450517PO	CAN AM DS 450EFI	■
130451017PR	CAN AM DS 450 XMX	■
130451017PO	CAN AM DS 450 XMX	■
130451513PR	CAN AM DS 650	■
130451513PO	CAN AM DS 650	■
130500508PR	SMC RAM 250/150	■
130500508PO	SMC RAM 250/150	■
130501008PR	SMC CAPTAIN 300	■
130501008PO	SMC CAPTAIN 300	■
130550509PR	DINLI DMX 450	■
130550509PO	DINLI DMX 450	■
130650508PR	AEON COBRA 350	■
130650508PO	AEON COBRA 350	■
130700514PR	ARTIC CAT DVX 400	■
130700514PO	ARTIC CAT DVX 400	■

Nome: Para-choques X8

Composição: Alumínio - Liga 6060 - Tratamento T5

Características: Tubo Ø 35 x 2.5

Name: Front Bumper X8

Composition: Aluminum - Special alloy 6060 with a T5 treatment

Technical features: Pipe Ø 35 x 2.5

X8



REF	Modelo/ Models	
130050519PR	YAMAHA YFM 700 R	■
130050519PO	YAMAHA YFM 700 R	■
130051011PR	YAMAHA YFS200 Blaster	■
130051011PO	YAMAHA YFS200 Blaster	■
130051512PR	YAMAHA YFM 350 WARRIOR	■
130051512PO	YAMAHA YFM 350 WARRIOR	■
130052014PR	YAMAHA 350 BANSHEE	■
130052014PO	YAMAHA 350 BANSHEE	■
130052514PR	YAMAHA YFM 350R	■
130052514PO	YAMAHA YFM 350R	■
130053013PR	YAMAHA YFM 660R	■
130053013PO	YAMAHA YFM 660R	■
130053521PR	YAMAHA YFZ 450	■
130053521PO	YAMAHA YFZ 450	■
130054014PR	YAMAHA YFM 250 R	■
130054014PO	YAMAHA YFM 250 R	■
130054519PR	YAMAHA YFZ 450 R	■
130054519PO	YAMAHA YFZ 450 R	■
130100519PR	SUZUKI LTR 450	■
130100519PO	SUZUKI LTR 450	■
130101020PR	SUZUKI LTZ 400	■
130101020PO	SUZUKI LTZ 400	■
130101520PR	SUZUKI LTZ 400 K9	■
130101520PO	SUZUKI LTZ 400 K9	■
130102009PR	SUZUKI LTZ 250	■
130102009PO	SUZUKI LTZ 250	■
130150512PR	POLARIS OUTLAW 500 IRS/525 IRS	■
130150512PO	POLARIS OUTLAW 500 IRS/525 IRS	■
130151013PR	POLARIS OUTLAW 525 S/450 MXR	■
130151013PO	POLARIS OUTLAW 525 S/450 MXR	■
130151512PR	POLARIS PREDATOR 500	■
130151512PO	POLARIS PREDATOR 500	■
130200512PR	KIMCO KXR 250	■
130200512PO	KIMCO KXR 250	■
130201012PR	KIMCO MAXXER 300	■
130201012PO	KIMCO MAXXER 300	■
130250509PR	HONDA TRX 250 EX	■
130250509PO	HONDA TRX 250 EX	■
130251015PR	HONDA TRX 400 EX	■
130251015PO	HONDA TRX 400 EX	■
130251515PR	HONDA TRX 400 EX - 2008	■
130251515PO	HONDA TRX 400 EX - 2008	■
130252018PR	HONDA TRX 450	■
130252018PO	HONDA TRX 450	■
130252512PR	HONDA TRX 700	■
130252512PO	HONDA TRX 700	■
130253012PR	HONDA TRX 300	■
130253012PO	HONDA TRX 300	■
130300517PR	KTM 450/525 XC	■
130300517PO	KTM 450/525 XC	■
130301017PR	KTM 505- 450 SX	■
130301017PO	KTM 505- 450 SX	■

130350511PR	ADLY 300	■
130350511PO	ADLY 300	■
130351011PR	ADLY 500	■
130351011PO	ADLY 500	■
130400515PR	KAWASAKI KFX 400	■
130400515PO	KAWASAKI KFX 400	■
130401017PR	KAWASAKI KFX 450	■
130401017PO	KAWASAKI KFX 450	■
130401512PR	KAWASAKI KFX 700	■
130401512PO	KAWASAKI KFX 700	■
130450518PR	CAN AM DS 450EFI	■
130450518PO	CAN AM DS 450EFI	■
130451018PR	CAN AM DS 450 XMX	■
130451018PO	CAN AM DS 450 XMX	■
130451514PR	CAN AM DS 650	■
130451514PO	CAN AM DS 650	■
130500509PR	SMC RAM 250/150	■
130500509PO	SMC RAM 250/150	■
130501009PR	SMC CAPTAIN 300	■
130501009PO	SMC CAPTAIN 300	■
130550510PR	DINLI DMX 450	■
130550510PO	DINLI DMX 450	■
130650509PR	AEON COBRA 350	■
130650509PO	AEON COBRA 350	■
130700515PR	ARTIC CAT DVX 400	■
130700515PO	ARTIC CAT DVX 400	■

Nome: Para-choques X10

Composição: Alumínio - Liga 6060 - Tratamento T5

Características: Tubo Ø 35 x 2.5

Name: Front Bumper X10

Composition: Aluminum - Special alloy 6060 with a T5 treatment

Technical features: Pipe Ø 35 x 2.5

X10

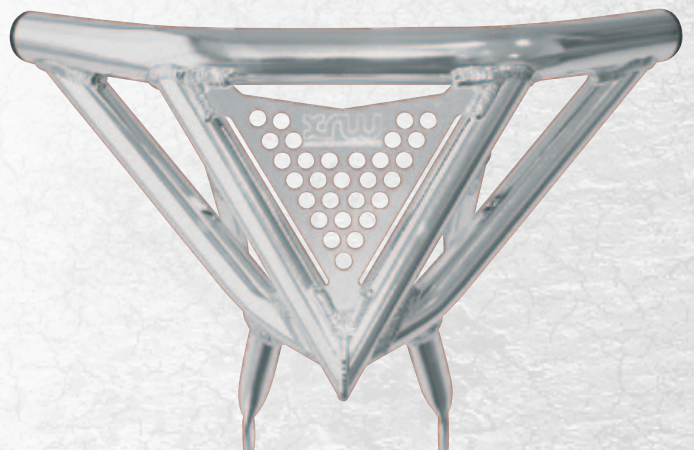

REF	Modelo/ Models	
130050520PR	YAMAHA YFM 700 R	■
130050520PO	YAMAHA YFM 700 R	■
130051012PR	YAMAHA YFS200 Blaster	■
130051012PO	YAMAHA YFS200 Blaster	■
130051513PR	YAMAHA YFM 350 WARRIOR	■
130051513PO	YAMAHA YFM 350 WARRIOR	■
130052015PR	YAMAHA 350 BANSHEE	■
130052015PO	YAMAHA 350 BANSHEE	■
130052515PR	YAMAHA YFM 350R	■
130052515PO	YAMAHA YFM 350R	■
130053014PR	YAMAHA YFM 660R	■
130053014PO	YAMAHA YFM 660R	■
130053522PR	YAMAHA YFZ 450	■
130053522PO	YAMAHA YFZ 450	■
130054015PR	YAMAHA YFM 250 R	■
130054015PO	YAMAHA YFM 250 R	■
130054520PR	YAMAHA YFZ 450 R	■
130054520PO	YAMAHA YFZ 450 R	■
130100520PR	SUZUKI LTR 450	■
130100520PO	SUZUKI LTR 450	■
130101021PR	SUZUKI LTZ 400	■
130101021PO	SUZUKI LTZ 400	■
130101521PR	SUZUKI LTZ 400 K9	■
130101521PO	SUZUKI LTZ 400 K9	■
130102010PR	SUZUKI LTZ 250	■
130102010PO	SUZUKI LTZ 250	■
130150513PR	POLARIS OUTLAW 500 IRS/525 IRS	■
130150513PO	POLARIS OUTLAW 500 IRS/525 IRS	■
130151014PR	POLARIS OUTLAW 525 S/450 MXR	■
130151014PO	POLARIS OUTLAW 525 S/450 MXR	■
130151513PR	POLARIS PREDATOR 500	■
130151513PO	POLARIS PREDATOR 500	■
130200513PR	KIMCO KXR 250	■
130200513PO	KIMCO KXR 250	■
130201013PR	KIMCO MAXXER 300	■
130201013PO	KIMCO MAXXER 300	■
130250510PR	HONDA TRX 250 EX	■
130250510PO	HONDA TRX 250 EX	■
130251016PR	HONDA TRX 400 EX	■
130251016PO	HONDA TRX 400 EX	■
130251516PR	HONDA TRX 400 EX - 2008	■
130251516PO	HONDA TRX 400 EX - 2008	■
130252019PR	HONDA TRX 450	■
130252019PO	HONDA TRX 450	■
130252513PR	HONDA TRX 700	■
130252513PO	HONDA TRX 700	■
130253013PR	HONDA TRX 300	■
130253013PO	HONDA TRX 300	■
130300518PR	KTM 450/525 XC	■
130300518PO	KTM 450/525 XC	■
130301018PR	KTM 505- 450 SX	■
130301018PO	KTM 505- 450 SX	■

130350512PR	ADLY 300	■
130350512PO	ADLY 300	■
130351012PR	ADLY 500	■
130351012PO	ADLY 500	■
130400516PR	KAWASAKI KFX 400	■
130400516PO	KAWASAKI KFX 400	■
130401018PR	KAWASAKI KFX 450	■
130401018PO	KAWASAKI KFX 450	■
130401513PR	KAWASAKI KFX 700	■
130401513PO	KAWASAKI KFX 700	■
130450519PR	CAN AM DS 450EFI	■
130450519PO	CAN AM DS 450EFI	■
130451019PR	CAN AM DS 450 XMX	■
130451019PO	CAN AM DS 450 XMX	■
130451515PR	CAN AM DS 650	■
130451515PO	CAN AM DS 650	■
130500510PR	SMC RAM 250/150	■
130500510PO	SMC RAM 250/150	■
130501010PR	SMC CAPTAIN 300	■
130501010PO	SMC CAPTAIN 300	■
130550511PR	DINLI DMX 450	■
130550511PO	DINLI DMX 450	■
130650510PR	AEON COBRA 350	■
130650510PO	AEON COBRA 350	■
130700516PR	ARTIC CAT DVX 400	■
130700516PO	ARTIC CAT DVX 400	■

Nome: Para-choques X15

Composição: Alumínio - Liga 6060 - Tratamento T5

Características: Tubo Ø 20 x 3

Name: Front Bumper X15

Composition: Aluminum - Special alloy 6060 with a T5 treatment

Technical features: Pipe Ø 20 x 3

X15



X16

REF	Modelo/ Models		
130050521PR	YAMAHA YFM 700 R	■	●
130050521PO	YAMAHA YFM 700 R	■	●
130050522PR	YAMAHA YFM 700 R	■	●
130050522PO	YAMAHA YFM 700 R	■	●
130050523PR	YAMAHA YFM 700 R	■	●
130050523PO	YAMAHA YFM 700 R	■	●
130050524PR	YAMAHA YFM 700 R	■	●
130050524PO	YAMAHA YFM 700 R	■	●
130050525PR	YAMAHA YFM 700 R	■	●
130050525PO	YAMAHA YFM 700 R	■	●
130050526PR	YAMAHA YFM 700 R	■	●
130050526PO	YAMAHA YFM 700 R	■	●
130051013PR	YAMAHA YFS200 Blaster	■	●
130051013PO	YAMAHA YFS200 Blaster	■	●
130051014PR	YAMAHA YFS200 Blaster	■	●
130051014PO	YAMAHA YFS200 Blaster	■	●
130051015PR	YAMAHA YFS200 Blaster	■	●
130051015PO	YAMAHA YFS200 Blaster	■	●
130051016PR	YAMAHA YFS200 Blaster	■	●
130051016PO	YAMAHA YFS200 Blaster	■	●
130051017PR	YAMAHA YFS200 Blaster	■	●
130051017PO	YAMAHA YFS200 Blaster	■	●
130051018PR	YAMAHA YFS200 Blaster	■	●
130051018PO	YAMAHA YFS200 Blaster	■	●
130051514PR	YAMAHA YFM 350 WARRIOR	■	●
130051514PO	YAMAHA YFM 350 WARRIOR	■	●
130051515PR	YAMAHA YFM 350 WARRIOR	■	●
130051515PO	YAMAHA YFM 350 WARRIOR	■	●
130051516PR	YAMAHA YFM 350 WARRIOR	■	●
130051516PO	YAMAHA YFM 350 WARRIOR	■	●
130051517PR	YAMAHA YFM 350 WARRIOR	■	●
130051517PO	YAMAHA YFM 350 WARRIOR	■	●
130051518PR	YAMAHA YFM 350 WARRIOR	■	●
130051518PO	YAMAHA YFM 350 WARRIOR	■	●
130051519PR	YAMAHA YFM 350 WARRIOR	■	●
130051519PO	YAMAHA YFM 350 WARRIOR	■	●
130052016PR	YAMAHA 350 BANSHEE	■	●
130052016PO	YAMAHA 350 BANSHEE	■	●
130052017PR	YAMAHA 350 BANSHEE	■	●
130052017PO	YAMAHA 350 BANSHEE	■	●
130052018PR	YAMAHA 350 BANSHEE	■	●
130052018PO	YAMAHA 350 BANSHEE	■	●
130052019PR	YAMAHA 350 BANSHEE	■	●
130052019PO	YAMAHA 350 BANSHEE	■	●
130052020PR	YAMAHA 350 BANSHEE	■	●
130052020PO	YAMAHA 350 BANSHEE	■	●
130052021PR	YAMAHA 350 BANSHEE	■	●
130052021PO	YAMAHA 350 BANSHEE	■	●
130052516PR	YAMAHA YFM 350R	■	●
130052516PO	YAMAHA YFM 350R	■	●
130052517PR	YAMAHA YFM 350R	■	●
130052517PO	YAMAHA YFM 350R	■	●
130052518PR	YAMAHA YFM 350R	■	●
130052518PO	YAMAHA YFM 350R	■	●
130052519PR	YAMAHA YFM 350R	■	●
130052519PO	YAMAHA YFM 350R	■	●
130052520PR	YAMAHA YFM 350R	■	●
130052520PO	YAMAHA YFM 350R	■	●

130052520PO	YAMAHA YFM 350R	■	●
130052521PR	YAMAHA YFM 350R	■	●
130052521PO	YAMAHA YFM 350R	■	●
130053015PR	YAMAHA YFM 660R	■	●
130053015PO	YAMAHA YFM 660R	■	●
130053016PR	YAMAHA YFM 660R	■	●
130053016PO	YAMAHA YFM 660R	■	●
130053017PR	YAMAHA YFM 660R	■	●
130053017PO	YAMAHA YFM 660R	■	●
130053018PR	YAMAHA YFM 660R	■	●
130053018PO	YAMAHA YFM 660R	■	●
130053019PR	YAMAHA YFM 660R	■	●
130053019PO	YAMAHA YFM 660R	■	●
130053020PR	YAMAHA YFM 660R	■	●
130053020PO	YAMAHA YFM 660R	■	●
130053523PR	YAMAHA YFZ 450	■	●
130053523PO	YAMAHA YFZ 450	■	●
130053524PR	YAMAHA YFZ 450	■	●
130053524PO	YAMAHA YFZ 450	■	●
130053525PR	YAMAHA YFZ 450	■	●
130053525PO	YAMAHA YFZ 450	■	●
130053526PR	YAMAHA YFZ 450	■	●
130053526PO	YAMAHA YFZ 450	■	●
130053527PR	YAMAHA YFZ 450	■	●
130053527PO	YAMAHA YFZ 450	■	●
130053528PR	YAMAHA YFZ 450	■	●
130053528PO	YAMAHA YFZ 450	■	●
130054016PR	YAMAHA YFM 250 R	■	●
130054016PO	YAMAHA YFM 250 R	■	●
130054017PR	YAMAHA YFM 250 R	■	●
130054017PO	YAMAHA YFM 250 R	■	●
130054018PR	YAMAHA YFM 250 R	■	●
130054018PO	YAMAHA YFM 250 R	■	●
130054019PR	YAMAHA YFM 250 R	■	●
130054019PO	YAMAHA YFM 250 R	■	●
130054020PR	YAMAHA YFM 250 R	■	●
130054020PO	YAMAHA YFM 250 R	■	●
130054021PR	YAMAHA YFM 250 R	■	●
130054021PO	YAMAHA YFM 250 R	■	●
130054521PR	YAMAHA YFZ 450 R	■	●
130054521PO	YAMAHA YFZ 450 R	■	●
130054522PR	YAMAHA YFZ 450 R	■	●
130054522PO	YAMAHA YFZ 450 R	■	●
130054523PR	YAMAHA YFZ 450 R	■	●
130054523PO	YAMAHA YFZ 450 R	■	●
130054524PR	YAMAHA YFZ 450 R	■	●
130054524PO	YAMAHA YFZ 450 R	■	●
130054525PR	YAMAHA YFZ 450 R	■	●
130054525PO	YAMAHA YFZ 450 R	■	●
130054526PR	YAMAHA YFZ 450 R	■	●
130054526PO	YAMAHA YFZ 450 R	■	●
130100521PR	SUZUKI LTR 450	■	●
130100521PO	SUZUKI LTR 450	■	●
130100522PR	SUZUKI LTR 450	■	●
130100522PO	SUZUKI LTR 450	■	●
130100523PR	SUZUKI LTR 450	■	●
130100523PO	SUZUKI LTR 450	■	●
130100524PR	SUZUKI LTR 450	■	●
130100524PO	SUZUKI LTR 450	■	●
130100525PR	SUZUKI LTR 450	■	●
130100525PO	SUZUKI LTR 450	■	●

REF

Modelo/ Model

Quady Śrem tel. 61 28 35 657 email: Biuro@sklep-atv.pl

REF

Modelo/ Models

130100525PO	SUZUKI LTR 450	■ ●
130100526PR	SUZUKI LTR 450	■ ●
130100526PO	SUZUKI LTR 450	■ ●
130101022PR	SUZUKI LTZ 400	■ ●
130101022PO	SUZUKI LTZ 400	■ ●
130101023PR	SUZUKI LTZ 400	■ ●
130101023PO	SUZUKI LTZ 400	■ ●
130101024PR	SUZUKI LTZ 400	■ ●
130101024PO	SUZUKI LTZ 400	■ ●
130101025PR	SUZUKI LTZ 400	■ ●
130101025PO	SUZUKI LTZ 400	■ ●
130101026PR	SUZUKI LTZ 400	■ ●
130101026PO	SUZUKI LTZ 400	■ ●
130101027PR	SUZUKI LTZ 400	■ ●
130101027PO	SUZUKI LTZ 400	■ ●
130101522PR	SUZUKI LTZ 400 K9	■ ●
130101522PO	SUZUKI LTZ 400 K9	■ ●
130101523PR	SUZUKI LTZ 400 K9	■ ●
130101523PO	SUZUKI LTZ 400 K9	■ ●
130101524PR	SUZUKI LTZ 400 K9	■ ●
130101524PO	SUZUKI LTZ 400 K9	■ ●
130101525PR	SUZUKI LTZ 400 K9	■ ●
130101525PO	SUZUKI LTZ 400 K9	■ ●
130101526PR	SUZUKI LTZ 400 K9	■ ●
130101526PO	SUZUKI LTZ 400 K9	■ ●
130101527PR	SUZUKI LTZ 400 K9	■ ●
130101527PO	SUZUKI LTZ 400 K9	■ ●
130102011PR	SUZUKI LTZ 250	■ ●
130102011PO	SUZUKI LTZ 250	■ ●
130102012PR	SUZUKI LTZ 250	■ ●
130102012PO	SUZUKI LTZ 250	■ ●
130102013PR	SUZUKI LTZ 250	■ ●
130102013PO	SUZUKI LTZ 250	■ ●
130102014PR	SUZUKI LTZ 250	■ ●
130102014PO	SUZUKI LTZ 250	■ ●
130102015PR	SUZUKI LTZ 250	■ ●
130102015PO	SUZUKI LTZ 250	■ ●
130102016PR	SUZUKI LTZ 250	■ ●
130102016PO	SUZUKI LTZ 250	■ ●
130150514PR	POLARIS OUTLAW 500 IRS/525 IRS	■ ●
130150514PO	POLARIS OUTLAW 500 IRS/525 IRS	■ ●
130150515PR	POLARIS OUTLAW 500 IRS/525 IRS	■ ●
130150515PO	POLARIS OUTLAW 500 IRS/525 IRS	■ ●
130150516PR	POLARIS OUTLAW 500 IRS/525 IRS	■ ●
130150516PO	POLARIS OUTLAW 500 IRS/525 IRS	■ ●
130150517PR	POLARIS OUTLAW 500 IRS/525 IRS	■ ●
130150517PO	POLARIS OUTLAW 500 IRS/525 IRS	■ ●
130150518PR	POLARIS OUTLAW 500 IRS/525 IRS	■ ●
130150518PO	POLARIS OUTLAW 500 IRS/525 IRS	■ ●
130150519PR	POLARIS OUTLAW 500 IRS/525 IRS	■ ●
130150519PO	POLARIS OUTLAW 500 IRS/525 IRS	■ ●
130151015PR	POLARIS OUTLAW 525 S/450 MXR	■ ●
130151015PO	POLARIS OUTLAW 525 S/450 MXR	■ ●
130151016PR	POLARIS OUTLAW 525 S/450 MXR	■ ●
130151016PO	POLARIS OUTLAW 525 S/450 MXR	■ ●
130151017PR	POLARIS OUTLAW 525 S/450 MXR	■ ●
130151017PO	POLARIS OUTLAW 525 S/450 MXR	■ ●
130151018PR	POLARIS OUTLAW 525 S/450 MXR	■ ●
130151018PO	POLARIS OUTLAW 525 S/450 MXR	■ ●
130151019PR	POLARIS OUTLAW 525 S/450 MXR	■ ●
130151019PO	POLARIS OUTLAW 525 S/450 MXR	■ ●

www.quadysrem.pl

130151019PO	POLARIS OUTLAW 525 S/450 MXR	■ ●
130151020PR	POLARIS OUTLAW 525 S/450 MXR	■ ●
130151020PO	POLARIS OUTLAW 525 S/450 MXR	■ ●
130151514PR	POLARIS PREDATOR 500	■ ●
130151514PO	POLARIS PREDATOR 500	■ ●
130151515PR	POLARIS PREDATOR 500	■ ●
130151515PO	POLARIS PREDATOR 500	■ ●
130151516PR	POLARIS PREDATOR 500	■ ●
130151516PO	POLARIS PREDATOR 500	■ ●
130151517PR	POLARIS PREDATOR 500	■ ●
130151517PO	POLARIS PREDATOR 500	■ ●
130151518PR	POLARIS PREDATOR 500	■ ●
130151518PO	POLARIS PREDATOR 500	■ ●
130151519PR	POLARIS PREDATOR 500	■ ●
130151519PO	POLARIS PREDATOR 500	■ ●
130200514PR	KIMCO KXR 250	■ ●
130200514PO	KIMCO KXR 250	■ ●
130200515PR	KIMCO KXR 250	■ ●
130200515PO	KIMCO KXR 250	■ ●
130200516PR	KIMCO KXR 250	■ ●
130200516PO	KIMCO KXR 250	■ ●
130200517PR	KIMCO KXR 250	■ ●
130200517PO	KIMCO KXR 250	■ ●
130200518PR	KIMCO KXR 250	■ ●
130200518PO	KIMCO KXR 250	■ ●
130200519PR	KIMCO KXR 250	■ ●
130200519PO	KIMCO KXR 250	■ ●
130201014PR	KIMCO MAXXER 300	■ ●
130201014PO	KIMCO MAXXER 300	■ ●
130201015PR	KIMCO MAXXER 300	■ ●
130201015PO	KIMCO MAXXER 300	■ ●
130201016PR	KIMCO MAXXER 300	■ ●
130201016PO	KIMCO MAXXER 300	■ ●
130201017PR	KIMCO MAXXER 300	■ ●
130201017PO	KIMCO MAXXER 300	■ ●
130201018PR	KIMCO MAXXER 300	■ ●
130201018PO	KIMCO MAXXER 300	■ ●
130201019PR	KIMCO MAXXER 300	■ ●
130201019PO	KIMCO MAXXER 300	■ ●
130250511PR	HONDA TRX 250 EX	■ ●
130250511PO	HONDA TRX 250 EX	■ ●
130250512PR	HONDA TRX 250 EX	■ ●
130250512PO	HONDA TRX 250 EX	■ ●
130250513PR	HONDA TRX 250 EX	■ ●
130250513PO	HONDA TRX 250 EX	■ ●
130250514PR	HONDA TRX 250 EX	■ ●
130250514PO	HONDA TRX 250 EX	■ ●
130250515PR	HONDA TRX 250 EX	■ ●
130250515PO	HONDA TRX 250 EX	■ ●
130250516PR	HONDA TRX 250 EX	■ ●
130250516PO	HONDA TRX 250 EX	■ ●
130251017PR	HONDA TRX 400 EX	■ ●
130251017PO	HONDA TRX 400 EX	■ ●
130251018PR	HONDA TRX 400 EX	■ ●
130251018PO	HONDA TRX 400 EX	■ ●
130251019PR	HONDA TRX 400 EX	■ ●
130251019PO	HONDA TRX 400 EX	■ ●
130251020PR	HONDA TRX 400 EX	■ ●
130251020PO	HONDA TRX 400 EX	■ ●

www.sklep-atv.pl

www.centrum-brp.pl

REF

Modelo/ Models

Quady Śrem tel. 61 28 35 657 email: Biuro@sklepatv.pl

REF

Modelo/ Models

130251021PR	HONDA TRX 400 EX	
130251021PO	HONDA TRX 400 EX	
130251022PR	HONDA TRX 400 EX	
130251022PO	HONDA TRX 400 EX	
130251517PR	HONDA TRX 400 EX - 2008	
130251517PO	HONDA TRX 400 EX - 2008	
130251518PR	HONDA TRX 400 EX - 2008	
130251518PO	HONDA TRX 400 EX - 2008	
130251519PR	HONDA TRX 400 EX - 2008	
130251519PO	HONDA TRX 400 EX - 2008	
130251520PR	HONDA TRX 400 EX - 2008	
130251520PO	HONDA TRX 400 EX - 2008	
130251521PR	HONDA TRX 400 EX - 2008	
130251521PO	HONDA TRX 400 EX - 2008	
130251522PR	HONDA TRX 400 EX - 2008	
130251522PO	HONDA TRX 400 EX - 2008	
130252020PR	HONDA TRX 450	
130252020PO	HONDA TRX 450	
130252021PR	HONDA TRX 450	
130252021PO	HONDA TRX 450	
130252022PR	HONDA TRX 450	
130252022PO	HONDA TRX 450	
130252023PR	HONDA TRX 450	
130252023PO	HONDA TRX 450	
130252024PR	HONDA TRX 450	
130252024PO	HONDA TRX 450	
130252025PR	HONDA TRX 450	
130252025PO	HONDA TRX 450	
130252514PR	HONDA TRX 700	
130252514PO	HONDA TRX 700	
130252515PR	HONDA TRX 700	
130252515PO	HONDA TRX 700	
130252516PR	HONDA TRX 700	
130252516PO	HONDA TRX 700	
130252517PR	HONDA TRX 700	
130252517PO	HONDA TRX 700	
130252518PR	HONDA TRX 700	
130252518PO	HONDA TRX 700	
130252519PR	HONDA TRX 700	
130252519PO	HONDA TRX 700	
130253014PR	HONDA TRX 300	
130253014PO	HONDA TRX 300	
130253015PR	HONDA TRX 300	
130253015PO	HONDA TRX 300	
130253016PR	HONDA TRX 300	
130253016PO	HONDA TRX 300	
130253017PR	HONDA TRX 300	
130253017PO	HONDA TRX 300	
130253018PR	HONDA TRX 300	
130253018PO	HONDA TRX 300	
130253019PR	HONDA TRX 300	
130253019PO	HONDA TRX 300	
130300519PR	KTM 450/525 XC	
130300519PO	KTM 450/525 XC	
130300520PR	KTM 450/525 XC	
130300520PO	KTM 450/525 XC	
130300521PR	KTM 450/525 XC	
130300521PO	KTM 450/525 XC	
130300522PR	KTM 450/525 XC	
130300522PO	KTM 450/525 XC	

www.quadysrem.plwww.sklep-atv.pl

130300523PR	KTM 450/525 XC	
130300523PO	KTM 450/525 XC	
130300524PR	KTM 450/525 XC	
130300524PO	KTM 450/525 XC	
130301019PR	KTM 505- 450 SX	
130301019PO	KTM 505- 450 SX	
130301020PR	KTM 505- 450 SX	
130301020PO	KTM 505- 450 SX	
130301021PR	KTM 505- 450 SX	
130301021PO	KTM 505- 450 SX	
130301022PR	KTM 505- 450 SX	
130301022PO	KTM 505- 450 SX	
130301023PR	KTM 505- 450 SX	
130301023PO	KTM 505- 450 SX	
130301024PR	KTM 505- 450 SX	
130301024PO	KTM 505- 450 SX	
130350513PR	ADLY 300	
130350513PO	ADLY 300	
130350514PR	ADLY 300	
130350514PO	ADLY 300	
130350515PR	ADLY 300	
130350515PO	ADLY 300	
130350516PR	ADLY 300	
130350516PO	ADLY 300	
130350517PR	ADLY 300	
130350517PO	ADLY 300	
130350518PR	ADLY 300	
130350518PO	ADLY 300	
130351013PR	ADLY 500	
130351013PO	ADLY 500	
130351014PR	ADLY 500	
130351014PO	ADLY 500	
130351015PR	ADLY 500	
130351015PO	ADLY 500	
130351016PR	ADLY 500	
130351016PO	ADLY 500	
130351017PR	ADLY 500	
130351017PO	ADLY 500	
130351018PR	ADLY 500	
130351018PO	ADLY 500	
130400517PR	KAWASAKI KFX 400	
130400517PO	KAWASAKI KFX 400	
130400518PR	KAWASAKI KFX 400	
130400518PO	KAWASAKI KFX 400	
130400519PR	KAWASAKI KFX 400	
130400519PO	KAWASAKI KFX 400	
130400520PR	KAWASAKI KFX 400	
130400520PO	KAWASAKI KFX 400	
130400521PR	KAWASAKI KFX 400	
130400521PO	KAWASAKI KFX 400	
130400522PR	KAWASAKI KFX 400	
130400522PO	KAWASAKI KFX 400	
130401019PR	KAWASAKI KFX 450	
130401019PO	KAWASAKI KFX 450	
130401020PR	KAWASAKI KFX 450	
130401020PO	KAWASAKI KFX 450	
130401021PR	KAWASAKI KFX 450	
130401021PO	KAWASAKI KFX 450	
130401022PR	KAWASAKI KFX 450	
130401022PO	KAWASAKI KFX 450	

www.centrum-brp.pl

REF	Modelo/ Models		
130401023PR	KAWASAKI KFX 450	■	●
130401023PO	KAWASAKI KFX 450	■	●
130401024PR	KAWASAKI KFX 450	■	●
130401024PO	KAWASAKI KFX 450	■	●
130401514PR	KAWASAKI KFX 700	■	●
130401514PO	KAWASAKI KFX 700	■	●
130401515PR	KAWASAKI KFX 700	■	●
130401515PO	KAWASAKI KFX 700	■	●
130401516PR	KAWASAKI KFX 700	■	●
130401516PO	KAWASAKI KFX 700	■	●
130401517PR	KAWASAKI KFX 700	■	●
130401517PO	KAWASAKI KFX 700	■	●
130401518PR	KAWASAKI KFX 700	■	●
130401518PO	KAWASAKI KFX 700	■	●
130401519PR	KAWASAKI KFX 700	■	●
130401519PO	KAWASAKI KFX 700	■	●
130450520PR	CAN AM DS 450EFI	■	●
130450520PO	CAN AM DS 450EFI	■	●
130450521PR	CAN AM DS 450EFI	■	●
130450521PO	CAN AM DS 450EFI	■	●
130450522PR	CAN AM DS 450EFI	■	●
130450522PO	CAN AM DS 450EFI	■	●
130450523PR	CAN AM DS 450EFI	■	●
130450523PO	CAN AM DS 450EFI	■	●
130450524PR	CAN AM DS 450EFI	■	●
130450524PO	CAN AM DS 450EFI	■	●
130450525PR	CAN AM DS 450EFI	■	●
130450525PO	CAN AM DS 450EFI	■	●
130451020PR	CAN AM DS 450 XMX	■	●
130451020PO	CAN AM DS 450 XMX	■	●
130451021PR	CAN AM DS 450 XMX	■	●
130451021PO	CAN AM DS 450 XMX	■	●
130451022PR	CAN AM DS 450 XMX	■	●
130451022PO	CAN AM DS 450 XMX	■	●
130451023PR	CAN AM DS 450 XMX	■	●
130451023PO	CAN AM DS 450 XMX	■	●
130451024PR	CAN AM DS 450 XMX	■	●
130451024PO	CAN AM DS 450 XMX	■	●
130451025PR	CAN AM DS 450 XMX	■	●
130451025PO	CAN AM DS 450 XMX	■	●
130451516PR	CAN AM DS 650	■	●
130451516PO	CAN AM DS 650	■	●
130451517PR	CAN AM DS 650	■	●
130451517PO	CAN AM DS 650	■	●
130451518PR	CAN AM DS 650	■	●
130451518PO	CAN AM DS 650	■	●
130451519PR	CAN AM DS 650	■	●
130451519PO	CAN AM DS 650	■	●
130451520PR	CAN AM DS 650	■	●
130451520PO	CAN AM DS 650	■	●
130451521PR	CAN AM DS 650	■	●
130451521PO	CAN AM DS 650	■	●
130500511PR	SMC RAM 250/150	■	●
130500511PO	SMC RAM 250/150	■	●
130500512PR	SMC RAM 250/150	■	●
130500512PO	SMC RAM 250/150	■	●
130500513PR	SMC RAM 250/150	■	●
130500513PO	SMC RAM 250/150	■	●
130500514PR	SMC RAM 250/150	■	●
130500514PO	SMC RAM 250/150	■	●

REF	Modelo/ Models		
130500515PR	SMC RAM 250/150	■	●
130500515PO	SMC RAM 250/150	■	●
130500516PR	SMC RAM 250/150	■	●
130500516PO	SMC RAM 250/150	■	●
130501011PR	SMC CAPTAIN 300	■	●
130501011PO	SMC CAPTAIN 300	■	●
130501012PR	SMC CAPTAIN 300	■	●
130501012PO	SMC CAPTAIN 300	■	●
130501013PR	SMC CAPTAIN 300	■	●
130501013PO	SMC CAPTAIN 300	■	●
130501014PR	SMC CAPTAIN 300	■	●
130501014PO	SMC CAPTAIN 300	■	●
130501015PR	SMC CAPTAIN 300	■	●
130501015PO	SMC CAPTAIN 300	■	●
130501016PR	SMC CAPTAIN 300	■	●
130501016PO	SMC CAPTAIN 300	■	●
130550512PR	DINLI DMX 450	■	●
130550512PO	DINLI DMX 450	■	●
130550513PR	DINLI DMX 450	■	●
130550513PO	DINLI DMX 450	■	●
130550514PR	DINLI DMX 450	■	●
130550514PO	DINLI DMX 450	■	●
130550515PR	DINLI DMX 450	■	●
130550515PO	DINLI DMX 450	■	●
130550516PR	DINLI DMX 450	■	●
130550516PO	DINLI DMX 450	■	●
130550517PR	DINLI DMX 450	■	●
130550517PO	DINLI DMX 450	■	●
130650511PR	AEON COBRA 350	■	●
130650511PO	AEON COBRA 350	■	●
130650512PR	AEON COBRA 350	■	●
130650512PO	AEON COBRA 350	■	●
130650513PR	AEON COBRA 350	■	●
130650513PO	AEON COBRA 350	■	●
130650514PR	AEON COBRA 350	■	●
130650514PO	AEON COBRA 350	■	●
130650515PR	AEON COBRA 350	■	●
130650515PO	AEON COBRA 350	■	●
130650516PR	AEON COBRA 350	■	●
130650516PO	AEON COBRA 350	■	●
130700517PR	ARTIC CAT DVX 400	■	●
130700517PO	ARTIC CAT DVX 400	■	●
130700518PR	ARTIC CAT DVX 400	■	●
130700518PO	ARTIC CAT DVX 400	■	●
130700519PR	ARTIC CAT DVX 400	■	●
130700519PO	ARTIC CAT DVX 400	■	●

REF	Modelo/ Models		
130700520PR	ARTIC CAT DVX 400	<input checked="" type="checkbox"/>	<input checked="" type="checkbox"/>
130700520PO	ARTIC CAT DVX 400	<input type="checkbox"/>	<input checked="" type="checkbox"/>
130700521PR	ARTIC CAT DVX 400	<input checked="" type="checkbox"/>	<input checked="" type="checkbox"/>
130700521PO	ARTIC CAT DVX 400	<input type="checkbox"/>	<input checked="" type="checkbox"/>
130700522PR	ARTIC CAT DVX 400	<input checked="" type="checkbox"/>	<input checked="" type="checkbox"/>
130700522PO	ARTIC CAT DVX 400	<input type="checkbox"/>	<input checked="" type="checkbox"/>

Nome: Para-choques X16

Composição: Alumínio - Liga 6060 - Tratamento T5

Características: Tubo Ø 25 x 2.5

Name: Front Bumper X16

Composition: Aluminum - Special alloy 6060 with a T5 treatment

Technical features: Pipe Ø 25 x 2.5

●●●●●●● - PHD COLOR

X16



REF	Modelo/ Models		
130050527PR	YAMAHA YFM 700 R	<input checked="" type="checkbox"/>	<input type="checkbox"/>
130050527PO	YAMAHA YFM 700 R	<input type="checkbox"/>	<input type="checkbox"/>
130051019PR	YAMAHA YFS200 Blaster	<input checked="" type="checkbox"/>	<input type="checkbox"/>
130051019PO	YAMAHA YFS200 Blaster	<input type="checkbox"/>	<input type="checkbox"/>
130051520PR	YAMAHA YFM 350 WARRIOR	<input checked="" type="checkbox"/>	<input type="checkbox"/>
130051520PO	YAMAHA YFM 350 WARRIOR	<input type="checkbox"/>	<input type="checkbox"/>
130052022PR	YAMAHA 350 BANSHEE	<input checked="" type="checkbox"/>	<input type="checkbox"/>
130052022PO	YAMAHA 350 BANSHEE	<input type="checkbox"/>	<input type="checkbox"/>
130052522PR	YAMAHA YFM 350R	<input checked="" type="checkbox"/>	<input type="checkbox"/>
130052522PO	YAMAHA YFM 350R	<input type="checkbox"/>	<input type="checkbox"/>
130053021PR	YAMAHA YFM 660R	<input checked="" type="checkbox"/>	<input type="checkbox"/>
130053021PO	YAMAHA YFM 660R	<input type="checkbox"/>	<input type="checkbox"/>
130053529PR	YAMAHA YFZ 450	<input checked="" type="checkbox"/>	<input type="checkbox"/>
130053529PO	YAMAHA YFZ 450	<input type="checkbox"/>	<input type="checkbox"/>
130054022PR	YAMAHA YFM 250 R	<input checked="" type="checkbox"/>	<input type="checkbox"/>
130054022PO	YAMAHA YFM 250 R	<input type="checkbox"/>	<input type="checkbox"/>
130054527PR	YAMAHA YFZ 450 R	<input checked="" type="checkbox"/>	<input type="checkbox"/>
130054527PO	YAMAHA YFZ 450 R	<input type="checkbox"/>	<input type="checkbox"/>
130100527PR	SUZUKI LTR 450	<input checked="" type="checkbox"/>	<input type="checkbox"/>
130100527PO	SUZUKI LTR 450	<input type="checkbox"/>	<input type="checkbox"/>
130101028PR	SUZUKI LTZ 400	<input checked="" type="checkbox"/>	<input type="checkbox"/>
130101028PO	SUZUKI LTZ 400	<input type="checkbox"/>	<input type="checkbox"/>
130101528PR	SUZUKI LTZ 400 K9	<input checked="" type="checkbox"/>	<input type="checkbox"/>
130101528PO	SUZUKI LTZ 400 K9	<input type="checkbox"/>	<input type="checkbox"/>
130102017PR	SUZUKI LTZ 250	<input checked="" type="checkbox"/>	<input type="checkbox"/>
130102017PO	SUZUKI LTZ 250	<input type="checkbox"/>	<input type="checkbox"/>
130150520PR	POLARIS OUTLAW 500 IRS/525 IRS	<input checked="" type="checkbox"/>	<input type="checkbox"/>
130150520PO	POLARIS OUTLAW 500 IRS/525 IRS	<input type="checkbox"/>	<input type="checkbox"/>
130151021PR	POLARIS OUTLAW 525 S/450 MXR	<input checked="" type="checkbox"/>	<input type="checkbox"/>
130151021PO	POLARIS OUTLAW 525 S/450 MXR	<input type="checkbox"/>	<input type="checkbox"/>
130151520PR	POLARIS PREDATOR 500	<input checked="" type="checkbox"/>	<input type="checkbox"/>
130151520PO	POLARIS PREDATOR 500	<input type="checkbox"/>	<input type="checkbox"/>
130200520PR	KIMCO KXR 250	<input checked="" type="checkbox"/>	<input type="checkbox"/>
130200520PO	KIMCO KXR 250	<input type="checkbox"/>	<input type="checkbox"/>
130201020PR	KIMCO MAXXER 300	<input checked="" type="checkbox"/>	<input type="checkbox"/>
130201020PO	KIMCO MAXXER 300	<input type="checkbox"/>	<input type="checkbox"/>
130250517PR	HONDA TRX 250 EX	<input checked="" type="checkbox"/>	<input type="checkbox"/>
130250517PO	HONDA TRX 250 EX	<input type="checkbox"/>	<input type="checkbox"/>
130251023PR	HONDA TRX 400 EX	<input checked="" type="checkbox"/>	<input type="checkbox"/>
130251023PO	HONDA TRX 400 EX	<input type="checkbox"/>	<input type="checkbox"/>
130251523PR	HONDA TRX 400 EX - 2008	<input checked="" type="checkbox"/>	<input type="checkbox"/>
130251523PO	HONDA TRX 400 EX - 2008	<input type="checkbox"/>	<input type="checkbox"/>
130252026PR	HONDA TRX 450	<input checked="" type="checkbox"/>	<input type="checkbox"/>
130252026PO	HONDA TRX 450	<input type="checkbox"/>	<input type="checkbox"/>
130252520PR	HONDA TRX 700	<input checked="" type="checkbox"/>	<input type="checkbox"/>
130252520PO	HONDA TRX 700	<input type="checkbox"/>	<input type="checkbox"/>
130253020PR	HONDA TRX 300	<input checked="" type="checkbox"/>	<input type="checkbox"/>
130253020PO	HONDA TRX 300	<input type="checkbox"/>	<input type="checkbox"/>
130300525PR	KTM 450/525 XC	<input checked="" type="checkbox"/>	<input type="checkbox"/>
130300525PO	KTM 450/525 XC	<input type="checkbox"/>	<input type="checkbox"/>
130301025PR	KTM 505- 450 SX	<input checked="" type="checkbox"/>	<input type="checkbox"/>
130301025PO	KTM 505- 450 SX	<input type="checkbox"/>	<input type="checkbox"/>

XR9

REF	Modelo/ Models	
130350519PR	ADLY 300	<input checked="" type="checkbox"/>
130350519PO	ADLY 300	<input type="checkbox"/>
130351019PR	ADLY 500	<input checked="" type="checkbox"/>
130351019PO	ADLY 500	<input type="checkbox"/>
130400523PR	KAWASAKI KFX 400	<input checked="" type="checkbox"/>
130400523PO	KAWASAKI KFX 400	<input type="checkbox"/>
130401025PR	KAWASAKI KFX 450	<input checked="" type="checkbox"/>
130401025PO	KAWASAKI KFX 450	<input type="checkbox"/>
130401520PR	KAWASAKI KFX 700	<input checked="" type="checkbox"/>
130401520PO	KAWASAKI KFX 700	<input type="checkbox"/>
130450526PR	CAN AM DS 450EFI	<input checked="" type="checkbox"/>
130450526PO	CAN AM DS 450EFI	<input type="checkbox"/>
130451026PR	CAN AM DS 450 XMX	<input checked="" type="checkbox"/>
130451026PO	CAN AM DS 450 XMX	<input type="checkbox"/>
130451522PR	CAN AM DS 650	<input checked="" type="checkbox"/>
130451522PO	CAN AM DS 650	<input type="checkbox"/>
130500517PR	SMC RAM 250/150	<input checked="" type="checkbox"/>
130500517PO	SMC RAM 250/150	<input type="checkbox"/>
130501017PR	SMC CAPTAIN 300	<input checked="" type="checkbox"/>
130501017PO	SMC CAPTAIN 300	<input type="checkbox"/>
130550518PR	DINLI DMX 450	<input checked="" type="checkbox"/>
130550518PO	DINLI DMX 450	<input type="checkbox"/>
130650517PR	AEON COBRA 350	<input checked="" type="checkbox"/>
130650517PO	AEON COBRA 350	<input type="checkbox"/>
130700523PR	ARTIC CAT DVX 400	<input checked="" type="checkbox"/>
130700523PO	ARTIC CAT DVX 400	<input type="checkbox"/>

Nome: Para-choques XR8

Composição: Alumínio - Liga 6060 - Tratamento T5

Características: Tubo Ø 25 x 2.5

Name: Front Bumper XR8

Composition: Aluminum - Special alloy 6060 with a T5 treatment

Technical features: Pipe Ø 25 x 2.5

REF	Modelo/ Models	
130050528PR	YAMAHA YFM 700 R	<input checked="" type="checkbox"/>
130050528PO	YAMAHA YFM 700 R	<input type="checkbox"/>
130051020PR	YAMAHA YFS200 Blaster	<input checked="" type="checkbox"/>
130051020PO	YAMAHA YFS200 Blaster	<input type="checkbox"/>
130051521PR	YAMAHA YFM 350 WARRIOR	<input checked="" type="checkbox"/>
130051521PO	YAMAHA YFM 350 WARRIOR	<input type="checkbox"/>
130052023PR	YAMAHA 350 BANSHEE	<input checked="" type="checkbox"/>
130052023PO	YAMAHA 350 BANSHEE	<input type="checkbox"/>
130052523PR	YAMAHA YFM 350R	<input checked="" type="checkbox"/>
130052523PO	YAMAHA YFM 350R	<input type="checkbox"/>
130053022PR	YAMAHA YFM 660R	<input checked="" type="checkbox"/>
130053022PO	YAMAHA YFM 660R	<input type="checkbox"/>
130053530PR	YAMAHA YFZ 450	<input checked="" type="checkbox"/>
130053530PO	YAMAHA YFZ 450	<input type="checkbox"/>
130054023PR	YAMAHA YFM 250 R	<input checked="" type="checkbox"/>
130054023PO	YAMAHA YFM 250 R	<input type="checkbox"/>
130054528PR	YAMAHA YFZ 450 R	<input checked="" type="checkbox"/>
130054528PO	YAMAHA YFZ 450 R	<input type="checkbox"/>
130100528PR	SUZUKI LTR 450	<input checked="" type="checkbox"/>
130100528PO	SUZUKI LTR 450	<input type="checkbox"/>
130101029PR	SUZUKI LTZ 400	<input checked="" type="checkbox"/>
130101029PO	SUZUKI LTZ 400	<input type="checkbox"/>
130101529PR	SUZUKI LTZ 400 K9	<input checked="" type="checkbox"/>
130101529PO	SUZUKI LTZ 400 K9	<input type="checkbox"/>
130102018PR	SUZUKI LTZ 250	<input checked="" type="checkbox"/>
130102018PO	SUZUKI LTZ 250	<input type="checkbox"/>
130150521PR	POLARIS OUTLAW 500 IRS/525 IRS	<input checked="" type="checkbox"/>
130150521PO	POLARIS OUTLAW 500 IRS/525 IRS	<input type="checkbox"/>
130151022PR	POLARIS OUTLAW 525 S/450 MXR	<input checked="" type="checkbox"/>
130151022PO	POLARIS OUTLAW 525 S/450 MXR	<input type="checkbox"/>
130151521PR	POLARIS PREDATOR 500	<input checked="" type="checkbox"/>
130151521PO	POLARIS PREDATOR 500	<input type="checkbox"/>
130200521PR	KIMCO KXR 250	<input checked="" type="checkbox"/>
130200521PO	KIMCO KXR 250	<input type="checkbox"/>
130201021PR	KIMCO MAXXER 300	<input checked="" type="checkbox"/>
130201021PO	KIMCO MAXXER 300	<input type="checkbox"/>
130250518PR	HONDA TRX 250 EX	<input checked="" type="checkbox"/>
130250518PO	HONDA TRX 250 EX	<input type="checkbox"/>
130251024PR	HONDA TRX 400 EX	<input checked="" type="checkbox"/>
130251024PO	HONDA TRX 400 EX	<input type="checkbox"/>
130251524PR	HONDA TRX 400 EX - 2008	<input checked="" type="checkbox"/>
130251524PO	HONDA TRX 400 EX - 2008	<input type="checkbox"/>
130252027PR	HONDA TRX 450	<input checked="" type="checkbox"/>
130252027PO	HONDA TRX 450	<input type="checkbox"/>
130252521PR	HONDA TRX 700	<input checked="" type="checkbox"/>
130252521PO	HONDA TRX 700	<input type="checkbox"/>
130253021PR	HONDA TRX 300	<input checked="" type="checkbox"/>
130253021PO	HONDA TRX 300	<input type="checkbox"/>
130300526PR	KTM 450/525 XC	<input checked="" type="checkbox"/>
130300526PO	KTM 450/525 XC	<input type="checkbox"/>
130301026PR	KTM 505- 450 SX	<input checked="" type="checkbox"/>
130301026PO	KTM 505- 450 SX	<input type="checkbox"/>
130350520PR	ADLY 300	<input checked="" type="checkbox"/>
130350520PO	ADLY 300	<input type="checkbox"/>

XR8



XR10 (PLATE ALUM)

REF	Modelo/ Models	
130351020PR	ADLY 500	<input checked="" type="checkbox"/>
130351020PO	ADLY 500	<input type="checkbox"/>
130400524PR	KAWASAKI KFX 400	<input checked="" type="checkbox"/>
130400524PO	KAWASAKI KFX 400	<input type="checkbox"/>
130401026PR	KAWASAKI KFX 450	<input checked="" type="checkbox"/>
130401026PO	KAWASAKI KFX 450	<input type="checkbox"/>
130401521PR	KAWASAKI KFX 700	<input checked="" type="checkbox"/>
130401521PO	KAWASAKI KFX 700	<input type="checkbox"/>
130450527PR	CAN AM DS 450EFI	<input checked="" type="checkbox"/>
130450527PO	CAN AM DS 450EFI	<input type="checkbox"/>
130451027PR	CAN AM DS 450 XMX	<input checked="" type="checkbox"/>
130451027PO	CAN AM DS 450 XMX	<input type="checkbox"/>
130451523PR	CAN AM DS 650	<input checked="" type="checkbox"/>
130451523PO	CAN AM DS 650	<input type="checkbox"/>
130500518PR	SMC RAM 250/150	<input checked="" type="checkbox"/>
130500518PO	SMC RAM 250/150	<input type="checkbox"/>
130501018PR	SMC CAPTAIN 300	<input checked="" type="checkbox"/>
130501018PO	SMC CAPTAIN 300	<input type="checkbox"/>
130550519PR	DINLI DMX 450	<input checked="" type="checkbox"/>
130550519PO	DINLI DMX 450	<input type="checkbox"/>
130650518PR	AEON COBRA 350	<input checked="" type="checkbox"/>
130650518PO	AEON COBRA 350	<input type="checkbox"/>
130700524PR	ARTIC CAT DVX 400	<input checked="" type="checkbox"/>
130700524PO	ARTIC CAT DVX 400	<input type="checkbox"/>

Nome: Para-choques XR9

Composição: Alumínio - Liga 6060 - Tratamento T5

Características: Tubo Ø 27 x 3

Name: Front Bumper XR9

Composition: Aluminum - Special alloy 6060 with a T5 treatment

Technical features: Pipe Ø 27 x 3

REF	Modelo/ Models	
130050529PR	YAMAHA YFM 700 R	<input checked="" type="checkbox"/>
130050529PO	YAMAHA YFM 700 R	<input type="checkbox"/>
130051021PR	YAMAHA YFS200 Blaster	<input checked="" type="checkbox"/>
130051021PO	YAMAHA YFS200 Blaster	<input type="checkbox"/>
130051522PR	YAMAHA YFM 350 WARRIOR	<input checked="" type="checkbox"/>
130051522PO	YAMAHA YFM 350 WARRIOR	<input type="checkbox"/>
130052024PR	YAMAHA 350 BANSHEE	<input checked="" type="checkbox"/>
130052024PO	YAMAHA 350 BANSHEE	<input type="checkbox"/>
130052524PR	YAMAHA YFM 350R	<input checked="" type="checkbox"/>
130052524PO	YAMAHA YFM 350R	<input type="checkbox"/>
130053023PR	YAMAHA YFM 660R	<input checked="" type="checkbox"/>
130053023PO	YAMAHA YFM 660R	<input type="checkbox"/>
130053531PR	YAMAHA YFZ 450	<input checked="" type="checkbox"/>
130053531PO	YAMAHA YFZ 450	<input type="checkbox"/>
130054024PR	YAMAHA YFM 250 R	<input checked="" type="checkbox"/>
130054024PO	YAMAHA YFM 250 R	<input type="checkbox"/>
130054529PR	YAMAHA YFZ 450 R	<input checked="" type="checkbox"/>
130054529PO	YAMAHA YFZ 450 R	<input type="checkbox"/>
130100529PR	SUZUKI LTR 450	<input checked="" type="checkbox"/>
130100529PO	SUZUKI LTR 450	<input type="checkbox"/>
130101030PR	SUZUKI LTZ 400	<input checked="" type="checkbox"/>
130101030PO	SUZUKI LTZ 400	<input type="checkbox"/>
130101530PR	SUZUKI LTZ 400 K9	<input checked="" type="checkbox"/>
130101530PO	SUZUKI LTZ 400 K9	<input type="checkbox"/>
130102019PR	SUZUKI LTZ 250	<input checked="" type="checkbox"/>
130102019PO	SUZUKI LTZ 250	<input type="checkbox"/>
130150522PR	POLARIS OUTLAW 500 IRS/525 IRS	<input checked="" type="checkbox"/>
130150522PO	POLARIS OUTLAW 500 IRS/525 IRS	<input type="checkbox"/>
130151023PR	POLARIS OUTLAW 525 S/450 MXR	<input checked="" type="checkbox"/>
130151023PO	POLARIS OUTLAW 525 S/450 MXR	<input type="checkbox"/>
130151522PR	POLARIS PREDATOR 500	<input checked="" type="checkbox"/>
130151522PO	POLARIS PREDATOR 500	<input type="checkbox"/>
130200522PR	KIMCO KXR 250	<input checked="" type="checkbox"/>
130200522PO	KIMCO KXR 250	<input type="checkbox"/>
130201022PR	KIMCO MAXXER 300	<input checked="" type="checkbox"/>
130201022PO	KIMCO MAXXER 300	<input type="checkbox"/>
130250519PR	HONDA TRX 250 EX	<input checked="" type="checkbox"/>
130250519PO	HONDA TRX 250 EX	<input type="checkbox"/>
130251025PR	HONDA TRX 400 EX	<input checked="" type="checkbox"/>
130251025PO	HONDA TRX 400 EX	<input type="checkbox"/>
130251525PR	HONDA TRX 400 EX - 2008	<input checked="" type="checkbox"/>
130251525PO	HONDA TRX 400 EX - 2008	<input type="checkbox"/>
130252028PR	HONDA TRX 450	<input checked="" type="checkbox"/>
130252028PO	HONDA TRX 450	<input type="checkbox"/>
130252522PR	HONDA TRX 700	<input checked="" type="checkbox"/>
130252522PO	HONDA TRX 700	<input type="checkbox"/>
130253022PR	HONDA TRX 300	<input checked="" type="checkbox"/>
130253022PO	HONDA TRX 300	<input type="checkbox"/>
130300527PR	KTM 450/525 XC	<input checked="" type="checkbox"/>
130300527PO	KTM 450/525 XC	<input type="checkbox"/>
130301027PR	KTM 505- 450 SX	<input checked="" type="checkbox"/>
130301027PO	KTM 505- 450 SX	<input type="checkbox"/>

XR9

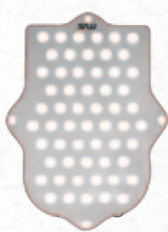

ESCORPIÃO
www.quadysrem.pl
Scorpion

CHAMA
Flame
www.sklep-atv.pl

www.centrum-brp.pl

XR10 (PHD COLOR)

REF	Modelo/ Models	
130350521PR	ADLY 300	■
130350521PO	ADLY 300	■
130351021PR	ADLY 500	■
130351021PO	ADLY 500	■
130400525PR	KAWASAKI KFX 400	■
130400525PO	KAWASAKI KFX 400	■
130401027PR	KAWASAKI KFX 450	■
130401027PO	KAWASAKI KFX 450	■
130401522PR	KAWASAKI KFX 700	■
130401522PO	KAWASAKI KFX 700	■
130450528PR	CAN AM DS 450EFI	■
130450528PO	CAN AM DS 450EFI	■
130451028PR	CAN AM DS 450 XMX	■
130451028PO	CAN AM DS 450 XMX	■
130451524PR	CAN AM DS 650	■
130451524PO	CAN AM DS 650	■
130500519PR	SMC RAM 250/150	■
130500519PO	SMC RAM 250/150	■
130501025PR	SMC CAPTAIN 300	■
130501025PO	SMC CAPTAIN 300	■
130550520PR	DINLI DMX 450	■
130550520PO	DINLI DMX 450	■
130650519PR	AEON COBRA 350	■
130650519PO	AEON COBRA 350	■
130700525PR	ARTIC CAT DVX 400	■
130700525PO	ARTIC CAT DVX 400	■

Nome: Para-choques XR10 (Plate Alum)

Composição: Alumínio - Liga 6060 - Tratamento T5

Características: Tubo Ø 35 x 2.5/ Ø 27 x 3

Name: Front Bumper XR10 (Plate Alum)

Composition: Aluminum - Special alloy 6060 with a T5 treatment

Technical features: Pipe Ø 35 x 2.5/ Ø 27 x 3

XR10 (PLATE ALUM)



REF	Modelo/ Models	
130050530PR	YAMAHA YFM 700 R	■
130050530PO	YAMAHA YFM 700 R	■
130050531PR	YAMAHA YFM 700 R	■
130050531PO	YAMAHA YFM 700 R	■
130050532PR	YAMAHA YFM 700 R	■
130050532PO	YAMAHA YFM 700 R	■
130050533PR	YAMAHA YFM 700 R	■
130050533PO	YAMAHA YFM 700 R	■
130050534PR	YAMAHA YFM 700 R	■
130050534PO	YAMAHA YFM 700 R	■
130050535PR	YAMAHA YFM 700 R	■
130050535PO	YAMAHA YFM 700 R	■
130051022PR	YAMAHA YFS200 Blaster	■
130051022PO	YAMAHA YFS200 Blaster	■
130051023PR	YAMAHA YFS200 Blaster	■
130051023PO	YAMAHA YFS200 Blaster	■
130051024PR	YAMAHA YFS200 Blaster	■
130051024PO	YAMAHA YFS200 Blaster	■
130051025PR	YAMAHA YFS200 Blaster	■
130051025PO	YAMAHA YFS200 Blaster	■
130051026PR	YAMAHA YFS200 Blaster	■
130051026PO	YAMAHA YFS200 Blaster	■
130051027PR	YAMAHA YFS200 Blaster	■
130051027PO	YAMAHA YFS200 Blaster	■
130051523PR	YAMAHA YFM 350 WARRIOR	■
130051523PO	YAMAHA YFM 350 WARRIOR	■
130051524PR	YAMAHA YFM 350 WARRIOR	■
130051524PO	YAMAHA YFM 350 WARRIOR	■
130051525PR	YAMAHA YFM 350 WARRIOR	■
130051525PO	YAMAHA YFM 350 WARRIOR	■
130051526PR	YAMAHA YFM 350 WARRIOR	■
130051526PO	YAMAHA YFM 350 WARRIOR	■
130051527PR	YAMAHA YFM 350 WARRIOR	■
130051527PO	YAMAHA YFM 350 WARRIOR	■
130051528PR	YAMAHA YFM 350 WARRIOR	■
130051528PO	YAMAHA YFM 350 WARRIOR	■
130052025PR	YAMAHA 350 BANSHEE	■
130052025PO	YAMAHA 350 BANSHEE	■
130052026PR	YAMAHA 350 BANSHEE	■
130052026PO	YAMAHA 350 BANSHEE	■
130052027PR	YAMAHA 350 BANSHEE	■
130052027PO	YAMAHA 350 BANSHEE	■
130052028PR	YAMAHA 350 BANSHEE	■
130052028PO	YAMAHA 350 BANSHEE	■
130052029PR	YAMAHA 350 BANSHEE	■
130052029PO	YAMAHA 350 BANSHEE	■
130052030PR	YAMAHA 350 BANSHEE	■
130052030PO	YAMAHA 350 BANSHEE	■
130052525PR	YAMAHA YFM 350R	■
130052525PO	YAMAHA YFM 350R	■
130052526PR	YAMAHA YFM 350R	■
130052526PO	YAMAHA YFM 350R	■
130052527PR	YAMAHA YFM 350R	■
130052527PO	YAMAHA YFM 350R	■

REF

Modelo/ Model

Quady Śrem tel. 61 28 35 657 em

BFBiurow@sklep

Model/ Models

130052528PR	YAMAHA YFM 350R	
130052528PO	YAMAHA YFM 350R	
130052529PR	YAMAHA YFM 350R	
130052529PO	YAMAHA YFM 350R	
130052530PR	YAMAHA YFM 350R	
130052530PO	YAMAHA YFM 350R	
130053024PR	YAMAHA YFM 660R	
130053024PO	YAMAHA YFM 660R	
130053025PR	YAMAHA YFM 660R	
130053025PO	YAMAHA YFM 660R	
130053026PR	YAMAHA YFM 660R	
130053026PO	YAMAHA YFM 660R	
130053027PR	YAMAHA YFM 660R	
130053027PO	YAMAHA YFM 660R	
130053028PR	YAMAHA YFM 660R	
130053028PO	YAMAHA YFM 660R	
130053029PR	YAMAHA YFM 660R	
130053029PO	YAMAHA YFM 660R	
130053532PR	YAMAHA YFZ 450	
130053532PO	YAMAHA YFZ 450	
130053533PR	YAMAHA YFZ 450	
130053533PO	YAMAHA YFZ 450	
130053534PR	YAMAHA YFZ 450	
130053534PO	YAMAHA YFZ 450	
130053535PR	YAMAHA YFZ 450	
130053535PO	YAMAHA YFZ 450	
130053536PR	YAMAHA YFZ 450	
130053536PO	YAMAHA YFZ 450	
130053537PR	YAMAHA YFZ 450	
130053537PO	YAMAHA YFZ 450	
130054025PR	YAMAHA YFM 250 R	
130054025PO	YAMAHA YFM 250 R	
130054026PR	YAMAHA YFM 250 R	
130054026PO	YAMAHA YFM 250 R	
130054027PR	YAMAHA YFM 250 R	
130054027PO	YAMAHA YFM 250 R	
130054028PR	YAMAHA YFM 250 R	
130054028PO	YAMAHA YFM 250 R	
130054029PR	YAMAHA YFM 250 R	
130054029PO	YAMAHA YFM 250 R	
130054030PR	YAMAHA YFM 250 R	
130054030PO	YAMAHA YFM 250 R	
130054530PR	YAMAHA YFZ 450 R	
130054530PO	YAMAHA YFZ 450 R	
130054531PR	YAMAHA YFZ 450 R	
130054531PO	YAMAHA YFZ 450 R	
130054532PR	YAMAHA YFZ 450 R	
130054532PO	YAMAHA YFZ 450 R	
130054533PR	YAMAHA YFZ 450 R	
130054533PO	YAMAHA YFZ 450 R	
130054534PR	YAMAHA YFZ 450 R	
130054534PO	YAMAHA YFZ 450 R	
130054535PR	YAMAHA YFZ 450 R	
130054535PO	YAMAHA YFZ 450 R	
130100530PR	SUZUKI LTR 450	
130100530PO	SUZUKI LTR 450	
130100531PR	SUZUKI LTR 450	
130100531PO	SUZUKI LTR 450	
130100532PR	SUZUKI LTR 450	
130100532PO	SUZUKI LTR 450	

www.quadysrem.pl

www.sklep-atv.pl

130100533PR	SUZUKI LTR 450	
130100533PO	SUZUKI LTR 450	
130100534PR	SUZUKI LTR 450	
130100534PO	SUZUKI LTR 450	
130100535PR	SUZUKI LTR 450	
130100535PO	SUZUKI LTR 450	
130101031PR	SUZUKI LTZ 400	
130101031PO	SUZUKI LTZ 400	
130101032PR	SUZUKI LTZ 400	
130101032PO	SUZUKI LTZ 400	
130101033PR	SUZUKI LTZ 400	
130101033PO	SUZUKI LTZ 400	
130101034PR	SUZUKI LTZ 400	
130101034PO	SUZUKI LTZ 400	
130101035PR	SUZUKI LTZ 400	
130101035PO	SUZUKI LTZ 400	
130101036PR	SUZUKI LTZ 400	
130101036PO	SUZUKI LTZ 400	
130101531PR	SUZUKI LTZ 400 K9	
130101531PO	SUZUKI LTZ 400 K9	
130101532PR	SUZUKI LTZ 400 K9	
130101532PO	SUZUKI LTZ 400 K9	
130101533PR	SUZUKI LTZ 400 K9	
130101533PO	SUZUKI LTZ 400 K9	
130101534PR	SUZUKI LTZ 400 K9	
130101534PO	SUZUKI LTZ 400 K9	
130101535PR	SUZUKI LTZ 400 K9	
130101535PO	SUZUKI LTZ 400 K9	
130101536PR	SUZUKI LTZ 400 K9	
130101536PO	SUZUKI LTZ 400 K9	
130102020PR	SUZUKI LTZ 250	
130102020PO	SUZUKI LTZ 250	
130102021PR	SUZUKI LTZ 250	
130102021PO	SUZUKI LTZ 250	
130102022PR	SUZUKI LTZ 250	
130102022PO	SUZUKI LTZ 250	
130102023PR	SUZUKI LTZ 250	
130102023PO	SUZUKI LTZ 250	
130102024PR	SUZUKI LTZ 250	
130102024PO	SUZUKI LTZ 250	
130102025PR	SUZUKI LTZ 250	
130102025PO	SUZUKI LTZ 250	
130150523PR	POLARIS OUTLAW 500 IRS/525 IRS	
130150523PO	POLARIS OUTLAW 500 IRS/525 IRS	
130150524PR	POLARIS OUTLAW 500 IRS/525 IRS	
130150524PO	POLARIS OUTLAW 500 IRS/525 IRS	
130150525PR	POLARIS OUTLAW 500 IRS/525 IRS	
130150525PO	POLARIS OUTLAW 500 IRS/525 IRS	
130150526PR	POLARIS OUTLAW 500 IRS/525 IRS	
130150526PO	POLARIS OUTLAW 500 IRS/525 IRS	
130150527PR	POLARIS OUTLAW 500 IRS/525 IRS	
130150527PO	POLARIS OUTLAW 500 IRS/525 IRS	
130150528PR	POLARIS OUTLAW 500 IRS/525 IRS	
130150528PO	POLARIS OUTLAW 500 IRS/525 IRS	
130151024PR	POLARIS OUTLAW 525 S/450 MXR	
130151024PO	POLARIS OUTLAW 525 S/450 MXR	
130151025PR	POLARIS OUTLAW 525 S/450 MXR	
130151025PO	POLARIS OUTLAW 525 S/450 MXR	
130151026PR	POLARIS OUTLAW 525 S/450 MXR	
130151026PO	POLARIS OUTLAW 525 S/450 MXR	

www.centrum-brp.pl

www.centrum-brp.pl

REF

Modelo/ Models

Quady Śrem tel. 61 28 35 657 email: biuro@sklepatv.pl

REF

Modelo/ Models

130151027PR	POLARIS OUTLAW 525 S/450 MXR	
130151027PO	POLARIS OUTLAW 525 S/450 MXR	
130151028PR	POLARIS OUTLAW 525 S/450 MXR	
130151028PO	POLARIS OUTLAW 525 S/450 MXR	
130151029PR	POLARIS OUTLAW 525 S/450 MXR	
130151029PO	POLARIS OUTLAW 525 S/450 MXR	
130151523PR	POLARIS PREDATOR 500	
130151523PO	POLARIS PREDATOR 500	
130151524PR	POLARIS PREDATOR 500	
130151524PO	POLARIS PREDATOR 500	
130151525PR	POLARIS PREDATOR 500	
130151525PO	POLARIS PREDATOR 500	
130151526PR	POLARIS PREDATOR 500	
130151526PO	POLARIS PREDATOR 500	
130151527PR	POLARIS PREDATOR 500	
130151527PO	POLARIS PREDATOR 500	
130151528PR	POLARIS PREDATOR 500	
130151528PO	POLARIS PREDATOR 500	
130200523PR	KIMCO KXR 250	
130200523PO	KIMCO KXR 250	
130200524PR	KIMCO KXR 250	
130200524PO	KIMCO KXR 250	
130200525PR	KIMCO KXR 250	
130200525PO	KIMCO KXR 250	
130200526PR	KIMCO KXR 250	
130200526PO	KIMCO KXR 250	
130200527PR	KIMCO KXR 250	
130200527PO	KIMCO KXR 250	
130200528PR	KIMCO KXR 250	
130200528PO	KIMCO KXR 250	
130201023PR	KIMCO MAXXER 300	
130201023PO	KIMCO MAXXER 300	
130201024PR	KIMCO MAXXER 300	
130201024PO	KIMCO MAXXER 300	
130201025PR	KIMCO MAXXER 300	
130201025PO	KIMCO MAXXER 300	
130201026PR	KIMCO MAXXER 300	
130201026PO	KIMCO MAXXER 300	
130201027PR	KIMCO MAXXER 300	
130201027PO	KIMCO MAXXER 300	
130201028PR	KIMCO MAXXER 300	
130201028PO	KIMCO MAXXER 300	
130250520PR	HONDA TRX 250 EX	
130250520PO	HONDA TRX 250 EX	
130250521PR	HONDA TRX 250 EX	
130250521PO	HONDA TRX 250 EX	
130250522PR	HONDA TRX 250 EX	
130250522PO	HONDA TRX 250 EX	
130250523PR	HONDA TRX 250 EX	
130250523PO	HONDA TRX 250 EX	
130250524PR	HONDA TRX 250 EX	
130250524PO	HONDA TRX 250 E	
130250525PR	HONDA TRX 250 EX	
130250525PO	HONDA TRX 250 EX	
130251026PR	HONDA TRX 400 EX	
130251026PO	HONDA TRX 400 EX	
130251027PR	HONDA TRX 400 EX	
130251027PO	HONDA TRX 400 EX	
130251028PR	HONDA TRX 400 EX	
130251028PO	HONDA TRX 400 EX	

www.quadyśrem.pl

130251029PR	HONDA TRX 400 EX	
130251029PO	HONDA TRX 400 EX	
130251030PR	HONDA TRX 400 EX	
130251030PO	HONDA TRX 400 EX	
130251031PR	HONDA TRX 400 EX	
130251031PO	HONDA TRX 400 EX	
130251526PR	HONDA TRX 400 EX - 2008	
130251526PO	HONDA TRX 400 EX - 2008	
130251527PR	HONDA TRX 400 EX - 2008	
130251527PO	HONDA TRX 400 EX - 2008	
130251528PR	HONDA TRX 400 EX - 2008	
130251528PO	HONDA TRX 400 EX - 2008	
130251529PR	HONDA TRX 400 EX - 2008	
130251529PO	HONDA TRX 400 EX - 2008	
130251530PR	HONDA TRX 400 EX - 2008	
130251530PO	HONDA TRX 400 EX - 2008	
130251531PR	HONDA TRX 400 EX - 2008	
130251531PO	HONDA TRX 400 EX - 2008	
130252029PR	HONDA TRX 450	
130252029PO	HONDA TRX 450	
130252030PR	HONDA TRX 450	
130252030PO	HONDA TRX 450	
130252031PR	HONDA TRX 450	
130252031PO	HONDA TRX 450	
130252032PR	HONDA TRX 450	
130252032PO	HONDA TRX 450	
130252033PR	HONDA TRX 450	
130252033PO	HONDA TRX 450	
130252034PR	HONDA TRX 450	
130252034PO	HONDA TRX 450	
130252523PR	HONDA TRX 700	
130252523PO	HONDA TRX 700	
130252524PR	HONDA TRX 700	
130252524PO	HONDA TRX 700	
130252525PR	HONDA TRX 700	
130252525PO	HONDA TRX 700	
130252526PR	HONDA TRX 700	
130252526PO	HONDA TRX 700	
130252527PR	HONDA TRX 700	
130252527PO	HONDA TRX 700	
130252528PR	HONDA TRX 700	
130252528PO	HONDA TRX 700	
130253023PR	HONDA TRX 300	
130253023PO	HONDA TRX 300	
130253024PR	HONDA TRX 300	
130253024PO	HONDA TRX 300	
130253025PR	HONDA TRX 300	
130253025PO	HONDA TRX 300	
130253026PR	HONDA TRX 300	
130253026PO	HONDA TRX 300	
130253027PR	HONDA TRX 300	
130253027PO	HONDA TRX 300	
130253028PR	HONDA TRX 300	
130253028PO	HONDA TRX 300	
130300528PR	KTM 450/525 XC	
130300528PO	KTM 450/525 XC	
130300529PR	KTM 450/525 XC	
130300529PO	KTM 450/525 XC	
130300530PR	KTM 450/525 XC	
130300530PO	KTM 450/525 XC	

www.sklep-atv.pl

www.centrum-brp.pl

REF	Modelo/ Models		
130300530PO	KTM 450/525 XC	■	●
130300531PR	KTM 450/525 XC	■	●
130300531PO	KTM 450/525 XC	■	●
130300532PR	KTM 450/525 XC	■	●
130300532PO	KTM 450/525 XC	■	●
130300533PR	KTM 450/525 XC	■	●
130300533PO	KTM 450/525 XC	■	●
130301028PR	KTM 505- 450 SX	■	●
130301028PO	KTM 505- 450 SX	■	●
130301029PR	KTM 505- 450 SX	■	●
130301029PO	KTM 505- 450 SX	■	●
130301030PR	KTM 505- 450 SX	■	●
130301030PO	KTM 505- 450 SX	■	●
130301031PR	KTM 505- 450 SX	■	●
130301031PO	KTM 505- 450 SX	■	●
130301032PR	KTM 505- 450 SX	■	●
130301032PO	KTM 505- 450 SX	■	●
130301033PR	KTM 505- 450 SX	■	●
130301033PO	KTM 505- 450 SX	■	●
130350522PR	ADLY 300	■	●
130350522PO	ADLY 300	■	●
130350523PR	ADLY 300	■	●
130350523PO	ADLY 300	■	●
130350524PR	ADLY 300	■	●
130350524PO	ADLY 300	■	●
130350525PR	ADLY 300	■	●
130350525PO	ADLY 300	■	●
130350526PR	ADLY 300	■	●
130350526PO	ADLY 300	■	●
130350527PR	ADLY 300	■	●
130350527PO	ADLY 300	■	●
130351022PR	ADLY 500	■	●
130351022PO	ADLY 500	■	●
130351023PR	ADLY 500	■	●
130351023PO	ADLY 500	■	●
130351024PR	ADLY 500	■	●
130351024PO	ADLY 500	■	●
130351025PR	ADLY 500	■	●
130351025PO	ADLY 500	■	●
130351026PR	ADLY 500	■	●
130351026PO	ADLY 500	■	●
130351027PR	ADLY 500	■	●
130351027PO	ADLY 500	■	●
130400526PR	KAWASAKI KFX 400	■	●
130400526PO	KAWASAKI KFX 400	■	●
130400527PR	KAWASAKI KFX 400	■	●
130400527PO	KAWASAKI KFX 400	■	●
130400528PR	KAWASAKI KFX 400	■	●
130400528PO	KAWASAKI KFX 400	■	●
130400529PR	KAWASAKI KFX 400	■	●
130400529PO	KAWASAKI KFX 400	■	●
130400530PR	KAWASAKI KFX 400	■	●
130400530PO	KAWASAKI KFX 400	■	●
130400531PR	KAWASAKI KFX 400	■	●
130400531PO	KAWASAKI KFX 400	■	●
130401028PR	KAWASAKI KFX 450	■	●
130401028PO	KAWASAKI KFX 450	■	●
130401029PR	KAWASAKI KFX 450	■	●
130401029PO	KAWASAKI KFX 450	■	●

REF	Modelo/ Models		
130401030PR	KAWASAKI KFX 450	■	●
130401030PO	KAWASAKI KFX 450	■	●
130401031PR	KAWASAKI KFX 450	■	●
130401031PO	KAWASAKI KFX 450	■	●
130401032PR	KAWASAKI KFX 450	■	●
130401032PO	KAWASAKI KFX 450	■	●
130401033PR	KAWASAKI KFX 450	■	●
130401033PO	KAWASAKI KFX 450	■	●
130401523PR	KAWASAKI KFX 700	■	●
130401523PO	KAWASAKI KFX 700	■	●
130401524PR	KAWASAKI KFX 700	■	●
130401524PO	KAWASAKI KFX 700	■	●
130401525PR	KAWASAKI KFX 700	■	●
130401525PO	KAWASAKI KFX 700	■	●
130401526PR	KAWASAKI KFX 700	■	●
130401526PO	KAWASAKI KFX 700	■	●
130401527PR	KAWASAKI KFX 700	■	●
130401527PO	KAWASAKI KFX 700	■	●
130401528PR	KAWASAKI KFX 700	■	●
130401528PO	KAWASAKI KFX 700	■	●
130450529PR	CAN AM DS 450EFI	■	●
130450529PO	CAN AM DS 450EFI	■	●
130450530PR	CAN AM DS 450EFI	■	●
130450530PO	CAN AM DS 450EFI	■	●
130450531PR	CAN AM DS 450EFI	■	●
130450531PO	CAN AM DS 450EFI	■	●
130450532PR	CAN AM DS 450EFI	■	●
130450532PO	CAN AM DS 450EFI	■	●
130450533PR	CAN AM DS 450EFI	■	●
130450533PO	CAN AM DS 450EFI	■	●
130450534PR	CAN AM DS 450EFI	■	●
130450534PO	CAN AM DS 450EFI	■	●
130451029PR	CAN AM DS 450 XMX	■	●
130451029PO	CAN AM DS 450 XMX	■	●
130451030PR	CAN AM DS 450 XMX	■	●
130451030PO	CAN AM DS 450 XMX	■	●
130451031PR	CAN AM DS 450 XMX	■	●
130451031PO	CAN AM DS 450 XMX	■	●
130451032PR	CAN AM DS 450 XMX	■	●
130451032PO	CAN AM DS 450 XMX	■	●
130451033PR	CAN AM DS 450 XMX	■	●
130451033PO	CAN AM DS 450 XMX	■	●
130451034PR	CAN AM DS 450 XMX	■	●
130451034PO	CAN AM DS 450 XMX	■	●
130451525PR	CAN AM DS 650	■	●
130451525PO	CAN AM DS 650	■	●
130451526PR	CAN AM DS 650	■	●
130451526PO	CAN AM DS 650	■	●
130451527PR	CAN AM DS 650	■	●
130451527PO	CAN AM DS 650	■	●
130451528PR	CAN AM DS 650	■	●
130451528PO	CAN AM DS 650	■	●
130451529PR	CAN AM DS 650	■	●
130451529PO	CAN AM DS 650	■	●
130451530PR	CAN AM DS 650	■	●
130451530PO	CAN AM DS 650	■	●
130500520PR	SMC RAM 250/150	■	●
130500520PO	SMC RAM 250/150	■	●
130500521PR	SMC RAM 250/150	■	●

REF	Modelo/ Models		
130500521PO	SMC RAM 250/150	■	●
130500522PR	SMC RAM 250/150	■	●
130500522PO	SMC RAM 250/150	■	●
130500523PR	SMC RAM 250/150	■	●
130500523PO	SMC RAM 250/150	■	●
130500524PR	SMC RAM 250/150	■	●
130500524PO	SMC RAM 250/150	■	●
130500525PR	SMC RAM 250/150	■	●
130500525PO	SMC RAM 250/150	■	●
130501020PR	SMC CAPTAIN 300	■	●
130501020PO	SMC CAPTAIN 300	■	●
130501021PR	SMC CAPTAIN 300	■	●
130501021PO	SMC CAPTAIN 300	■	●
130501022PR	SMC CAPTAIN 300	■	●
130501022PO	SMC CAPTAIN 300	■	●
130501023PR	SMC CAPTAIN 300	■	●
130501023PO	SMC CAPTAIN 300	■	●
130501024PR	SMC CAPTAIN 300	■	●
130501024PO	SMC CAPTAIN 300	■	●
130501025PR	SMC CAPTAIN 300	■	●
130501025PO	SMC CAPTAIN 300	■	●
130550521PR	DINLI DMX 450	■	●
130550521PO	DINLI DMX 450	■	●
130550522PR	DINLI DMX 450	■	●
130550522PO	DINLI DMX 450	■	●
130550523PR	DINLI DMX 450	■	●
130550523PO	DINLI DMX 450	■	●
130550524PR	DINLI DMX 450	■	●
130550524PO	DINLI DMX 450	■	●
130550525PR	DINLI DMX 450	■	●
130550525PO	DINLI DMX 450	■	●
130550526PR	DINLI DMX 450	■	●
130550526PO	DINLI DMX 450	■	●
130650520PR	AEON COBRA 350	■	●
130650520PO	AEON COBRA 350	■	●
130650521PR	AEON COBRA 350	■	●
130650521PO	AEON COBRA 350	■	●
130650522PR	AEON COBRA 350	■	●
130650522PO	AEON COBRA 350	■	●
130650523PR	AEON COBRA 350	■	●
130650523PO	AEON COBRA 350	■	●

REF	Modelo/ Models		
130650524PR	AEON COBRA 350	■	●
130650524PO	AEON COBRA 350	■	●
130650525PR	AEON COBRA 350	■	●
130650525PO	AEON COBRA 350	■	●
130700526PR	ARTIC CAT DVX 400	■	●
130700526PO	ARTIC CAT DVX 400	■	●
130700527PR	ARTIC CAT DVX 400	■	●
130700527PO	ARTIC CAT DVX 400	■	●
130700528PR	ARTIC CAT DVX 400	■	●
130700528PO	ARTIC CAT DVX 400	■	●
130700529PR	ARTIC CAT DVX 400	■	●
130700529PO	ARTIC CAT DVX 400	■	●
130700530PR	ARTIC CAT DVX 400	■	●
130700530PO	ARTIC CAT DVX 400	■	●
130700531PR	ARTIC CAT DVX 400	■	●
130700531PO	ARTIC CAT DVX 400	■	●

Nome: Para-choques XR10 (PHD COLOR)
 Composição: Alumínio - Liga 6060 - Tratamento T5
 Características: Tubo Ø 35 x 2.5/ Ø 27 x 3

Name: Front Bumper XR10 (PHD COLOR)
 Composition: Aluminum - Special alloy 6060 with a T5 treatment
 Technical features: Pipe Ø 35 x 2.5/ Ø 27 x 3

● ● ● ● ● ● - PHD COLOR

XR10 (PHD COLOR)



REF	Modelo/ Models	
130050541PR	YAMAHA YFM 700 R	■
130050541PO	YAMAHA YFM 700 R	□
130051028PR	YAMAHA YFS200 Blaster	■
130051028PO	YAMAHA YFS200 Blaster	□
130051530PR	YAMAHA YFM 350 WARRIOR	■
130051530PO	YAMAHA YFM 350 WARRIOR	□
130052031PR	YAMAHA 350 BANSHEE	■
130052031PO	YAMAHA 350 BANSHEE	□
130052534PR	YAMAHA YFM 350R	■
130052535PO	YAMAHA YFM 350R	□
130053033PR	YAMAHA YFM 660R	■
130053034PR	YAMAHA YFM 660R	□
130053542PR	YAMAHA YFZ 450	■
130053542PO	YAMAHA YFZ 450	□
130054035PR	YAMAHA YFM 250 R	■
130054035PO	YAMAHA YFM 250 R	□
130054539PR	YAMAHA YFZ 450 R	■
130054539PO	YAMAHA YFZ 450 R	□
130100541PR	SUZUKI LTR 450	■
130100541PO	SUZUKI LTR 450	□
130101042PR	SUZUKI LTZ 400	■
130101042PO	SUZUKI LTZ 400	□
130101542PR	SUZUKI LTZ 400 K9	■
130101542PO	SUZUKI LTZ 400 K9	□
130102026PR	SUZUKI LTZ 250	■
130102026PO	SUZUKI LTZ 250	□
130150530PR	POLARIS OUTLAW 500 IRS/525 IRS	■
130150530PO	POLARIS OUTLAW 500 IRS/525 IRS	□
130151032PR	POLARIS OUTLAW 525 S/450 MXR	■
130151032PO	POLARIS OUTLAW 525 S/450 MXR	□
130151532PR	POLARIS PREDATOR 500	■
130151532PO	POLARIS PREDATOR 500	□
130200529PR	KIMCO KXR 250	■
130200529PO	KIMCO KXR 250	□
130201029PR	KIMCO MAXXER 300	■
130201029PO	KIMCO MAXXER 300	□
130250526PR	HONDA TRX 250 EX	■
130250526PO	HONDA TRX 250 EX	□
130251034PR	HONDA TRX 400 EX	■
130251034PO	HONDA TRX 400 EX	□
130251534PR	HONDA TRX 400 EX - 2008	■
130251534PO	HONDA TRX 400 EX - 2008	□
130252038PR	HONDA TRX 450	■
130252038PO	HONDA TRX 450	□
130252530PR	HONDA TRX 700	■
130252530PO	HONDA TRX 700	□
130253029PR	HONDA TRX 300	■
130253029PO	HONDA TRX 300	□
130300537PR	KTM 450/525 XC	■
130300537PO	KTM 450/525 XC	□
130301037PR	KTM 505- 450 SX	■
130301037PO	KTM 505- 450 SX	□

REF	Modelo/ Models	
130350528PR	ADLY 300	■
130350528PO	ADLY 300	□
130351028PR	ADLY 500	■
130351028PO	ADLY 500	□
130400534PR	KAWASAKI KFX 400	■
130400534PO	KAWASAKI KFX 400	□
130401038PR	KAWASAKI KFX 450	■
130401038PO	KAWASAKI KFX 450	□
130401529PR	KAWASAKI KFX 700	■
130401529PO	KAWASAKI KFX 700	□
130450539PR	CAN AM DS 450EFI	■
130450539PO	CAN AM DS 450EFI	□
130451040PR	CAN AM DS 450 XMX	■
130451040PO	CAN AM DS 450 XMX	□
130451531PR	CAN AM DS 650	■
130451531PO	CAN AM DS 650	□
130500526PR	SMC RAM 250/150	■
130500526PO	SMC RAM 250/150	□
130501025PR	SMC CAPTAIN 300	■
130501025PO	SMC CAPTAIN 300	□
130700535PR	ARTIC CAT DVX 400	■
130700535PO	ARTIC CAT DVX 400	□

Nome: Nerf Bar Basic

Composição: Alumínio - Liga 6060 - Tratamento T5

Características: Tubo Ø 35 x 2.5

Name: Nerf Bar Basic

Composition: Aluminum - Special alloy 6060 with a T5 treatment

Technical features: Pipe Ø 35 x 2.5

NERF BAR BASIC

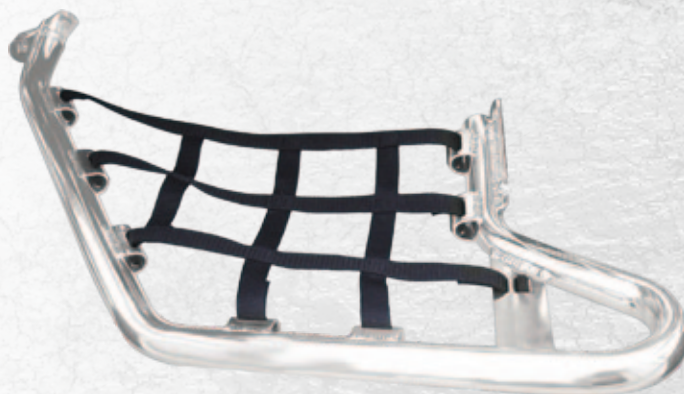

REF	Modelo/ Models	
130050539PR	YAMAHA YFM 700 R	<input checked="" type="checkbox"/>
130050539PO	YAMAHA YFM 700 R	<input type="checkbox"/>
130052533PR	YAMAHA YFM 350R	<input checked="" type="checkbox"/>
130052533PO	YAMAHA YFM 350R	<input type="checkbox"/>
130053032PR	YAMAHA YFM 660R	<input checked="" type="checkbox"/>
130053032PO	YAMAHA YFM 660R	<input type="checkbox"/>
130053540PR	YAMAHA YFZ 450	<input checked="" type="checkbox"/>
130053540PO	YAMAHA YFZ 450	<input type="checkbox"/>
130054033PR	YAMAHA YFM 250 R	<input checked="" type="checkbox"/>
130054033PO	YAMAHA YFM 250 R	<input type="checkbox"/>
130054537PR	YAMAHA YFZ 450 R	<input checked="" type="checkbox"/>
130054537PO	YAMAHA YFZ 450 R	<input type="checkbox"/>
130100539PR	SUZUKI LTR 450	<input checked="" type="checkbox"/>
130100539PO	SUZUKI LTR 450	<input type="checkbox"/>
130101040PR	SUZUKI LTZ 400	<input checked="" type="checkbox"/>
130101040PO	SUZUKI LTZ 400	<input type="checkbox"/>
130101540PR	SUZUKI LTZ 400 K9	<input checked="" type="checkbox"/>
130101540PO	SUZUKI LTZ 400 K9	<input type="checkbox"/>
130151531PR	POLARIS PREDATOR 500	<input checked="" type="checkbox"/>
130151531PO	POLARIS PREDATOR 500	<input type="checkbox"/>
130251033PR	HONDA TRX 400 EX	<input checked="" type="checkbox"/>
130251033PO	HONDA TRX 400 EX	<input type="checkbox"/>
130251533PR	HONDA TRX 400 EX - 2008	<input checked="" type="checkbox"/>
130251533PO	HONDA TRX 400 EX - 2008	<input type="checkbox"/>
130252037PR	HONDA TRX 450	<input checked="" type="checkbox"/>
130252037PO	HONDA TRX 450	<input type="checkbox"/>
130400533PR	KAWASAKI KFX 400	<input checked="" type="checkbox"/>
130400533PO	KAWASAKI KFX 400	<input type="checkbox"/>
130401036PR	KAWASAKI KFX 450	<input checked="" type="checkbox"/>
130401036PO	KAWASAKI KFX 450	<input type="checkbox"/>
130450538PR	CAN AM DS 450EFI	<input checked="" type="checkbox"/>
130450538PO	CAN AM DS 450EFI	<input type="checkbox"/>
130451039PR	CAN AM DS 450 XMx	<input checked="" type="checkbox"/>
130451039PO	CAN AM DS 450 XMx	<input type="checkbox"/>
130700534PR	ARTIC CAT DVX 400	<input checked="" type="checkbox"/>
130700534PO	ARTIC CAT DVX 400	<input type="checkbox"/>

REF	Modelo/ Models	
130050544PR	YAMAHA YFM 700 R	<input checked="" type="checkbox"/>
130050544PO	YAMAHA YFM 700 R	<input type="checkbox"/>
130051533PR	YAMAHA YFM 350 WARRIOR	<input checked="" type="checkbox"/>
130051533PO	YAMAHA YFM 350 WARRIOR	<input type="checkbox"/>
130052033PR	YAMAHA 350 BANSHEE	<input checked="" type="checkbox"/>
130052033PO	YAMAHA 350 BANSHEE	<input type="checkbox"/>
130052538PR	YAMAHA YFM 350R	<input checked="" type="checkbox"/>
130052538PO	YAMAHA YFM 350R	<input type="checkbox"/>
130053037PR	YAMAHA YFM 660R	<input checked="" type="checkbox"/>
130053037PO	YAMAHA YFM 660R	<input type="checkbox"/>
130053545PR	YAMAHA YFZ 450	<input checked="" type="checkbox"/>
130053545PO	YAMAHA YFZ 450	<input type="checkbox"/>
130054038PR	YAMAHA YFM 250 R	<input checked="" type="checkbox"/>
130054038PO	YAMAHA YFM 250 R	<input type="checkbox"/>
130054542PR	YAMAHA YFZ 450 R	<input checked="" type="checkbox"/>
130054542PO	YAMAHA YFZ 450 R	<input type="checkbox"/>
130100544PR	SUZUKI LTR 450	<input checked="" type="checkbox"/>
130100544PO	SUZUKI LTR 450	<input type="checkbox"/>
130101045PR	SUZUKI LTZ 400	<input checked="" type="checkbox"/>
130101045PO	SUZUKI LTZ 400	<input type="checkbox"/>
130101545PR	SUZUKI LTZ 400 K9	<input checked="" type="checkbox"/>
130101545PO	SUZUKI LTZ 400 K9	<input type="checkbox"/>
130151535PR	POLARIS PREDATOR 500	<input checked="" type="checkbox"/>
130151535PO	POLARIS PREDATOR 500	<input type="checkbox"/>
130251037PR	HONDA TRX 400 EX	<input checked="" type="checkbox"/>
130251037PO	HONDA TRX 400 EX	<input type="checkbox"/>
130251537PR	HONDA TRX 400 EX - 2008	<input checked="" type="checkbox"/>
130251537PO	HONDA TRX 400 EX - 2008	<input type="checkbox"/>
130252041PR	HONDA TRX 450	<input checked="" type="checkbox"/>
130252041PO	HONDA TRX 450	<input type="checkbox"/>
130300540PR	KTM 450/525 XC	<input checked="" type="checkbox"/>
130300540PO	KTM 450/525 XC	<input type="checkbox"/>
130301040PR	KTM 505- 450 SX	<input checked="" type="checkbox"/>
130301040PO	KTM 505- 450 SX	<input type="checkbox"/>
130400537PR	KAWASAKI KFX 400	<input checked="" type="checkbox"/>
130400537PO	KAWASAKI KFX 400	<input type="checkbox"/>
130401041PR	KAWASAKI KFX 450	<input checked="" type="checkbox"/>
130401041PO	KAWASAKI KFX 450	<input type="checkbox"/>
130401532PR	KAWASAKI KFX 700	<input checked="" type="checkbox"/>
130401532PO	KAWASAKI KFX 700	<input type="checkbox"/>
130450542PR	CAN AM DS 450EFI	<input checked="" type="checkbox"/>
130450542PO	CAN AM DS 450EFI	<input type="checkbox"/>
130451043PR	CAN AM DS 450 XMx	<input checked="" type="checkbox"/>
130451043PO	CAN AM DS 450 XMx	<input type="checkbox"/>
130700538PR	ARTIC CAT DVX 400	<input checked="" type="checkbox"/>
130700538PO	ARTIC CAT DVX 400	<input type="checkbox"/>

Nome: Proteção Calcanhar
Composição: Alumínio - Liga 6060 - Tratamento T5
Características: Tubo Ø 27 x 3

Name: Heel Guard
Composition: Aluminum - Special alloy 6060 with a T5 treatment
Technical features: Pipe Ø 27 x 3

PROTEÇÃO CALCANHAR HEEL GUARD



www.quadysrem.pl

Nome: Nerf Bar Racing
Composição: Alumínio - Liga 6060 - Tratamento T6
Características: Tubo Ø 35 x 2.5

Name: Nerf Bar Racing
Composition: Aluminum - Special alloy 6060 with a T6 treatment
Technical features: Pipe Ø 35 x 2.5

NERF BAR RACING

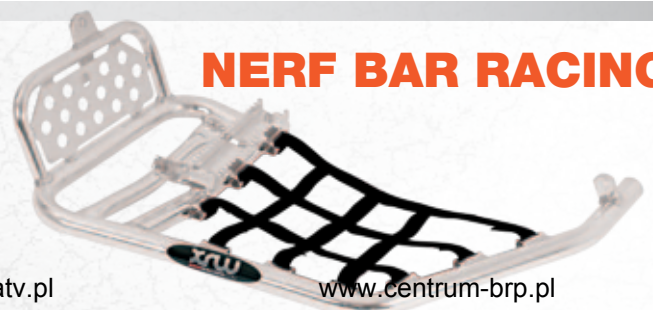

www.sklep-atv.pl

www.centrum-brp.pl

REF	Modelo/ Models	
130050543PR	YAMAHA YFM 700 R	<input checked="" type="checkbox"/>
130050543PO	YAMAHA YFM 700 R	<input type="checkbox"/>
130051532PR	YAMAHA YFM 350 WARRIOR	<input checked="" type="checkbox"/>
130051532PO	YAMAHA YFM 350 WARRIOR	<input type="checkbox"/>
130052537PR	YAMAHA YFM 350R	<input checked="" type="checkbox"/>
130052537PO	YAMAHA YFM 350R	<input type="checkbox"/>
130053036PR	YAMAHA YFM 660R	<input checked="" type="checkbox"/>
130053036PO	YAMAHA YFM 660R	<input type="checkbox"/>
130053544PR	YAMAHA YFZ 450	<input checked="" type="checkbox"/>
130053544PO	YAMAHA YFZ 450	<input type="checkbox"/>
130054037PR	YAMAHA YFM 250 R	<input checked="" type="checkbox"/>
130054037PO	YAMAHA YFM 250 R	<input type="checkbox"/>
130054541PR	YAMAHA YFZ 450 R	<input checked="" type="checkbox"/>
130054541PO	YAMAHA YFZ 450 R	<input type="checkbox"/>
130100543PR	SUZUKI LTR 450	<input checked="" type="checkbox"/>
130100543PO	SUZUKI LTR 450	<input type="checkbox"/>
130101044PR	SUZUKI LTZ 400	<input checked="" type="checkbox"/>
130101044PO	SUZUKI LTZ 400	<input type="checkbox"/>
130101544PR	SUZUKI LTZ 400 K9	<input checked="" type="checkbox"/>
130101544PO	SUZUKI LTZ 400 K9	<input type="checkbox"/>
130150532PR	POLARIS OUTLAW 500 IRS/525 IR	<input checked="" type="checkbox"/>
130150532PO	POLARIS OUTLAW 500 IRS/525 IR	<input type="checkbox"/>
130151034PR	POLARIS OUTLAW 525 S/450 MXF	<input checked="" type="checkbox"/>
130151034PO	POLARIS OUTLAW 525 S/450 MXF	<input type="checkbox"/>
130151534PR	POLARIS PREDATOR 500	<input checked="" type="checkbox"/>
130151534PO	POLARIS PREDATOR 500	<input type="checkbox"/>
130251036PR	HONDA TRX 400 EX	<input checked="" type="checkbox"/>
130251036PO	HONDA TRX 400 EX	<input type="checkbox"/>
130251536PR	HONDA TRX 400 EX - 2008	<input checked="" type="checkbox"/>
130251536PO	HONDA TRX 400 EX - 2008	<input type="checkbox"/>
130252040PR	HONDA TRX 450	<input checked="" type="checkbox"/>
130252040PO	HONDA TRX 450	<input type="checkbox"/>
130252532PR	HONDA TRX 700	<input checked="" type="checkbox"/>
130252532PO	HONDA TRX 700	<input type="checkbox"/>
130253031PR	HONDA TRX 300	<input checked="" type="checkbox"/>
130253031PO	HONDA TRX 300	<input type="checkbox"/>
130300539PR	KTM 450/525 XC	<input checked="" type="checkbox"/>
130300539PO	KTM 450/525 XC	<input type="checkbox"/>

REF	Modelo/ Models	
130301039PR	KTM 505- 450 SX	<input checked="" type="checkbox"/>
130301039PO	KTM 505- 450 SX	<input type="checkbox"/>
130400536PR	KAWASAKI KFX 400	<input checked="" type="checkbox"/>
130400536PO	KAWASAKI KFX 400	<input type="checkbox"/>
130401040PR	KAWASAKI KFX 450	<input checked="" type="checkbox"/>
130401040PO	KAWASAKI KFX 450	<input type="checkbox"/>
130401531PR	KAWASAKI KFX 700	<input checked="" type="checkbox"/>
130401531PO	KAWASAKI KFX 700	<input type="checkbox"/>
130450541PR	CAN AM DS 450EFI	<input checked="" type="checkbox"/>
130450541PO	CAN AM DS 450EFI	<input type="checkbox"/>
130451042PR	CAN AM DS 450 XMX	<input checked="" type="checkbox"/>
130451042PO	CAN AM DS 450 XMX	<input type="checkbox"/>
130700537PR	ARTIC CAT DVX 400	<input checked="" type="checkbox"/>
130700537PO	ARTIC CAT DVX 400	<input type="checkbox"/>

Nome: Nerf Bar R1 Maxx
 Composição: Alumínio - Liga 6060 - Tratamento T6
 Características: Tubo Ø 35 x 2,5

Name: Nerf Bar R1 Maxx
 Composition: Aluminum - Special alloy 6060 with a T6 treatment
 Technical features: Pipe Ø 35 x 2.5

NERF BAR R1 MAXX



NERF BAR R1

REF	Modelo/ Models	
130050546PR	YAMAHA YFM 700 R	<input checked="" type="checkbox"/>
130050546PO	YAMAHA YFM 700 R	<input type="checkbox"/>
130053546PO	YAMAHA YFZ 450	<input checked="" type="checkbox"/>
130053546PR	YAMAHA YFZ 450	<input type="checkbox"/>
130054039PR	YAMAHA YFM 250 R	<input checked="" type="checkbox"/>
130054039PO	YAMAHA YFM 250 R	<input type="checkbox"/>
130054543PR	YAMAHA YFZ 450 R	<input checked="" type="checkbox"/>
130054543PO	YAMAHA YFZ 450 R	<input type="checkbox"/>
130100545PR	SUZUKI LTR 450	<input checked="" type="checkbox"/>
130100545PO	SUZUKI LTR 450	<input type="checkbox"/>
130300542PR	KTM 450/525 XC	<input checked="" type="checkbox"/>
130300542PO	KTM 450/525 XC	<input type="checkbox"/>
130301042PR	KTM 505- 450 SX	<input checked="" type="checkbox"/>
130301042PO	KTM 505- 450 SX	<input type="checkbox"/>

Nome: Racing2012

Composição: Alumínio - Liga 6060 - Tratamento T6

Características: Tubo Ø 35 x 2.5

Name: Racing2012

Composition: Aluminum - Special alloy 6060 with a T6 treatment

Technical features: Pipe Ø 35 x 2.5

REF	Modelo/ Models	
130050542PR	YAMAHA YFM 700 R	<input checked="" type="checkbox"/>
130050542PO	YAMAHA YFM 700 R	<input type="checkbox"/>
130051531PR	YAMAHA YFM 350 WARRIOR	<input checked="" type="checkbox"/>
130051531PO	YAMAHA YFM 350 WARRIOR	<input type="checkbox"/>
130052032PR	YAMAHA 350 BANSHEE	<input checked="" type="checkbox"/>
130052032PO	YAMAHA 350 BANSHEE	<input type="checkbox"/>
130052535PR	YAMAHA YFM 350R	<input checked="" type="checkbox"/>
130052536PO	YAMAHA YFM 350R	<input type="checkbox"/>
130053034PO	YAMAHA YFM 660R	<input checked="" type="checkbox"/>
130053035NA	YAMAHA YFM 660R	<input type="checkbox"/>
130053543PR	YAMAHA YFZ 450	<input checked="" type="checkbox"/>
130053543PO	YAMAHA YFZ 450	<input type="checkbox"/>
130054036PR	YAMAHA YFM 250 R	<input checked="" type="checkbox"/>
130054036PO	YAMAHA YFM 250 R	<input type="checkbox"/>
130054540PR	YAMAHA YFZ 450 R	<input checked="" type="checkbox"/>
130054540PO	YAMAHA YFZ 450 R	<input type="checkbox"/>
130100542PR	SUZUKI LTR 450	<input checked="" type="checkbox"/>
130100542PO	SUZUKI LTR 450	<input type="checkbox"/>
130101043PR	SUZUKI LTZ 400	<input checked="" type="checkbox"/>
130101043PO	SUZUKI LTZ 400	<input type="checkbox"/>
130101543PR	SUZUKI LTZ 400 K9	<input checked="" type="checkbox"/>
130101543PO	SUZUKI LTZ 400 K9	<input type="checkbox"/>
130150531PR	POLARIS OUTLAW 500 IRS/525 IRS	<input checked="" type="checkbox"/>
130150531PO	POLARIS OUTLAW 500 IRS/525 IRS	<input type="checkbox"/>
130151033PR	POLARIS OUTLAW 525 S/450 MXF	<input checked="" type="checkbox"/>
130151033PO	POLARIS OUTLAW 525 S/450 MXF	<input type="checkbox"/>
130151533PR	POLARIS PREDATOR 500	<input checked="" type="checkbox"/>
130151533PO	POLARIS PREDATOR 500	<input type="checkbox"/>
130200530PR	KIMCO KXR 250	<input checked="" type="checkbox"/>
130200530PO	KIMCO KXR 250	<input type="checkbox"/>
130201030PR	KIMCO MAXXER 300	<input checked="" type="checkbox"/>
130201030PO	KIMCO MAXXER 300	<input type="checkbox"/>
130251035PR	HONDA TRX 400 EX	<input checked="" type="checkbox"/>
130251035PO	HONDA TRX 400 EX	<input type="checkbox"/>
130251535PR	HONDA TRX 400 EX - 2008	<input checked="" type="checkbox"/>
130251535PO	HONDA TRX 400 EX - 2008	<input type="checkbox"/>
130252039PR	HONDA TRX 450	<input checked="" type="checkbox"/>
130252039PO	HONDA TRX 450	<input type="checkbox"/>
130252531PR	HONDA TRX 700	<input checked="" type="checkbox"/>
130252531PO	HONDA TRX 700	<input type="checkbox"/>
130253030PR	HONDA TRX 300	<input checked="" type="checkbox"/>
130253030PO	HONDA TRX 300	<input type="checkbox"/>
130300538PR	KTM 450/525 XC	<input checked="" type="checkbox"/>
130300538PO	KTM 450/525 XC	<input type="checkbox"/>
130301038PR	KTM 505- 450 SX	<input checked="" type="checkbox"/>
130301038PO	KTM 505- 450 SX	<input type="checkbox"/>
130400535PR	KAWASAKI KFX 400	<input checked="" type="checkbox"/>
130400535PO	KAWASAKI KFX 400	<input type="checkbox"/>
130401039PR	KAWASAKI KFX 450	<input checked="" type="checkbox"/>
130401039PO	KAWASAKI KFX 450	<input type="checkbox"/>
130401530PR	KAWASAKI KFX 700	<input checked="" type="checkbox"/>
130401530PO	KAWASAKI KFX 700	<input type="checkbox"/>

RACING 2012

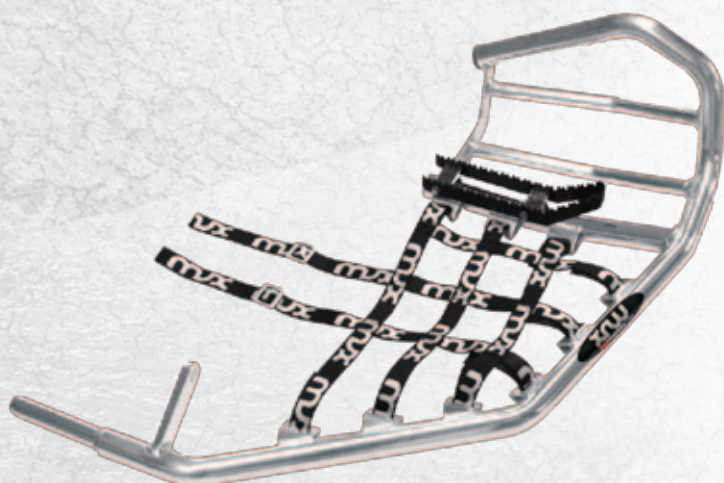

REF	Modelo/ Models	
130450540PR	CAN AM DS 450EFI	<input checked="" type="checkbox"/>
130450540PO	CAN AM DS 450EFI	<input type="checkbox"/>
130451041PR	CAN AM DS 450 XMX	<input checked="" type="checkbox"/>
130451041PO	CAN AM DS 450 XMX	<input type="checkbox"/>
130650526PR	AEON COBRA 350	<input checked="" type="checkbox"/>
130650526PO	AEON COBRA 350	<input type="checkbox"/>
130700536PR	ARTIC CAT DVX 400	<input checked="" type="checkbox"/>
130700536PO	ARTIC CAT DVX 400	<input type="checkbox"/>

Nome: Nerf Bar R1

Composição: Alumínio - Liga 6060 - Tratamento T6

Características: Tubo Ø 35 x 2.5

Name: Nerf Bar R1

Composition: Aluminum - Special alloy 6060 with a T6 treatment

Technical features: Pipe Ø 35 x 2.5

NERF BAR R1

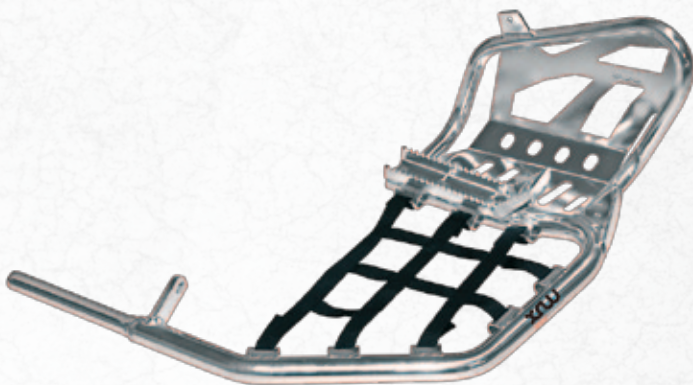

REF	Modelo/ Models	
130050545PR	YAMAHA YFM 700 R	<input checked="" type="checkbox"/>
130050545PO	YAMAHA YFM 700 R	<input type="checkbox"/>
130052034PR	YAMAHA 350 BANSHEE	<input checked="" type="checkbox"/>
130052034PO	YAMAHA 350 BANSHEE	<input type="checkbox"/>
130053547PR	YAMAHA YFZ 450	<input checked="" type="checkbox"/>
130053547PO	YAMAHA YFZ 450	<input type="checkbox"/>
130054544PR	YAMAHA YFZ 450 R	<input checked="" type="checkbox"/>
130054544PO	YAMAHA YFZ 450 R	<input type="checkbox"/>
130100546PR	SUZUKI LTR 450	<input checked="" type="checkbox"/>
130100546PO	SUZUKI LTR 450	<input type="checkbox"/>
130101046PR	SUZUKI LTZ 400	<input checked="" type="checkbox"/>
130101046PO	SUZUKI LTZ 400	<input type="checkbox"/>
130101546PR	SUZUKI LTZ 400 K9	<input checked="" type="checkbox"/>
130101546PO	SUZUKI LTZ 400 K9	<input type="checkbox"/>
130252042PR	HONDA TRX 450	<input checked="" type="checkbox"/>
130252042PO	HONDA TRX 450	<input type="checkbox"/>
130252533PR	HONDA TRX 700	<input checked="" type="checkbox"/>
130252533PO	HONDA TRX 700	<input type="checkbox"/>
130300541PR	KTM 450/525 XC	<input checked="" type="checkbox"/>
130300541PO	KTM 450/525 XC	<input type="checkbox"/>
130301041PR	KTM 505- 450 SX	<input checked="" type="checkbox"/>
130301041PO	KTM 505- 450 SX	<input type="checkbox"/>
130401042PR	KAWASAKI KFX 450	<input checked="" type="checkbox"/>
130401042PO	KAWASAKI KFX 450	<input type="checkbox"/>
130450543PR	CAN AM DS 450EFI	<input checked="" type="checkbox"/>
130450543PO	CAN AM DS 450EFI	<input type="checkbox"/>
130451044PR	CAN AM DS 450 XMX	<input checked="" type="checkbox"/>
130451044PO	CAN AM DS 450 XMX	<input type="checkbox"/>
130451532PR	CAN AM DS 650	<input checked="" type="checkbox"/>
130451532PO	CAN AM DS 650	<input type="checkbox"/>

Nome: Nerf Bar Q1

Composição: Alumínio - Liga 6061 - Tratamento T6

Características: Tubo Ø 35 x 2.5

Name: Nerf Bar Q1

Composition: Aluminum - Special alloy 6061 with a T6 treatment

Technical features: Pipe Ø 35 x 2.5

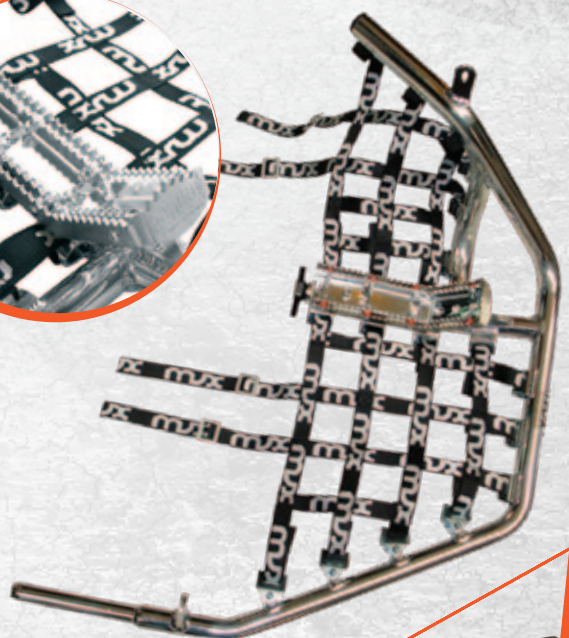
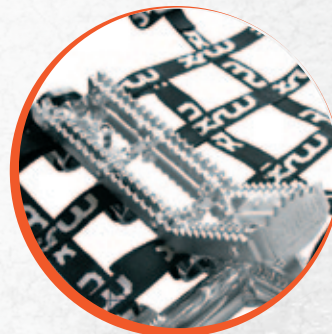

NERF BAR Q2

Quady Śrem tel. 61 28 35 657 email: biuro@sklep-atv.pl

KIT QUAD'S

REF	Modelo/ Models	
130050547PR	YAMAHA YFM 700 R	■
130050547PO	YAMAHA YFM 700 R	■
130053548PR	YAMAHA YFZ 450	■
130053548PO	YAMAHA YFZ 450	■
130054545PR	YAMAHA YFZ 450 R	■
130054545PO	YAMAHA YFZ 450 R	■
130100547PR	SUZUKI LTR 450	■
130100547PO	SUZUKI LTR 450	■
130101047PR	SUZUKI LTZ 400	■
130101047PO	SUZUKI LTZ 400	■
130101547PR	SUZUKI LTZ 400 K9	■
130101547PO	SUZUKI LTZ 400 K9	■
130251038PR	HONDA TRX 400 EX	■
130251038PO	HONDA TRX 400 EX	■
130251538PR	HONDA TRX 400 EX - 2008	■
130251538PO	HONDA TRX 400 EX - 2008	■
130252043PR	HONDA TRX 450	■
130252043PO	HONDA TRX 450	■
130252534PR	HONDA TRX 700	■
130252534PO	HONDA TRX 700	■
130300543PR	KTM 450/525 XC	■
130300543PO	KTM 450/525 XC	■
130301043PR	KTM 505- 450 SX	■
130301043PO	KTM 505- 450 SX	■
130400538PR	KAWASAKI KFX 400	■
130400538PO	KAWASAKI KFX 400	■
130401043PR	KAWASAKI KFX 450	■
130401043PO	KAWASAKI KFX 450	■
130450544PR	CAN AM DS 450EFI	■
130450544PO	CAN AM DS 450EFI	■
130451045PR	CAN AM DS 450 XMX	■
130451045PO	CAN AM DS 450 XMX	■
130700539PR	ARTIC CAT DVX 400	■
130700539PO	ARTIC CAT DVX 400	■

REF	Modelo/ Models
130050540NA	YAMAHA YFM 700 R
130052534NA	YAMAHA YFM 350R
130053033NA	YAMAHA YFM 660R
130053541NA	YAMAHA YFZ 450
130054034NA	YAMAHA YFM 250 R
130054538NA	YAMAHA YFZ 450 R
130100540NA	SUZUKI LTR 450
130101041NA	SUZUKI LTZ 400
130101541NA	SUZUKI LTZ 400 K9
130401037PR	KAWASAKI KFX 450

Nome: Kit Completo Quad
Alarg Frente + Alarg Trás + Prot. Motor + Prot. Triang +
Nerf Bar R1+ Para-Choque X6 + Laterais Quadro + Prot. Disco

Name: Complete Kit for Quad
Wheel Spacer Front and Back + Skid Plate + Prot. A-arms +
Nerf Bar R1+ Front Bumper X6 + Frame Guard + Disco Cover

Nome: Nerf Bar Q2
Composição: Alumínio - Liga 6061 - Tratamento T6
Características: Tubo Ø 35 x 2,5

Name: Nerf Bar Q2
Composition: Aluminum - Special alloy 6061 with a T6 treatment
Technical features: Pipe Ø 35 x 2.5

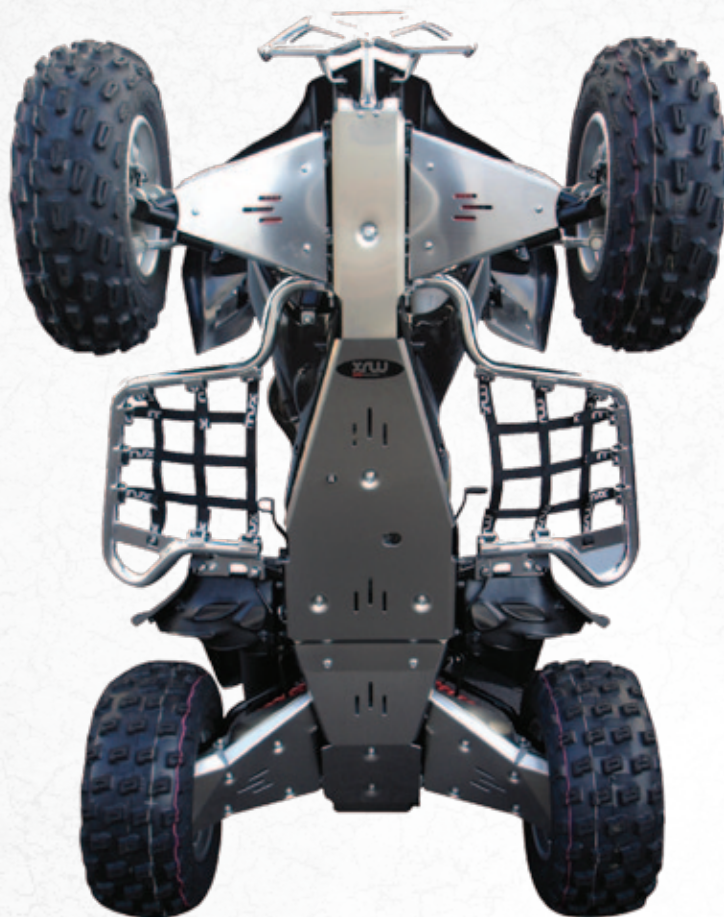
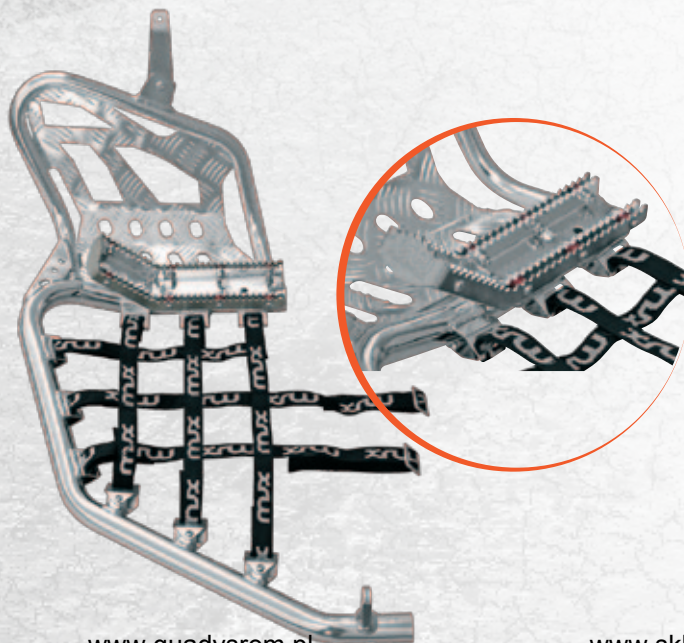

PROTEÇÕES EM PHD/ PHD PROTECTIONS

BUMPER TRASEIRO PHD BACK BUMPER PHD



REF	Modelo/ Models
130050501PH	YAMAHA YFM 700 R
130053501PH	YAMAHA YFZ 450
130054001PH	YAMAHA YFM 250 R
130054501PH	YAMAHA YFZ 450 R
130100501PH	SUZUKI LTR 450
130101001PH	SUZUKI LTZ 400
130101501PH	SUZUKI LTZ 400 K9
130252001PH	HONDA TRX 450
130300501PH	KTM 450/525 XC
130301001PH	KTM 505- 450 SX
130401051PH	KAWASAKI KFX 450
130450501PH	CAN AM DS 450EFI
130451001PH	CAN AM DS 450 XMX
130451501PH	CAN AM DS 650

Nome: Bumper Traseiro PHD
Composição: PEHD 300 - (Polietileno de alta densidade)
Características: Chapa (esp.) 8 mm

Name: Back Bumper PHD
Composition: PEHD 300 - (High density polyethylene)
Technical features: Plate (thickness) 8 mm

PROTEÇÃO DISCO PHD DISC COVER PHD



REF	Modelo/ Models
130050509PH	YAMAHA YFM 700 R
130053511PH	YAMAHA YFZ 450
130054509PH	YAMAHA YFZ 450 R
130100509PH	SUZUKI LTR 450
130101010PH	SUZUKI LTZ 400
130101510PH	SUZUKI LTZ 400 K9
130300507PH	KTM 450/525 XC
130301007PH	KTM 505- 450 SX
130401008PH	KAWASAKI KFX 450
130450508PH	CAN AM DS 450EFI
130451008PH	CAN AM DS 450 XMX

Nome: Proteção Disco PHD
Composição: PHD 300 (Polietileno de alta densidade)
Características: Chapa (esp.) 12 mm

Name: Disc Cover PHD
Composition: PHD 300 (High density polyethylene)
Technical features: Plate (thickness) 12 mm

PROTEÇÃO DISCO PHD

DISC COVER PHD

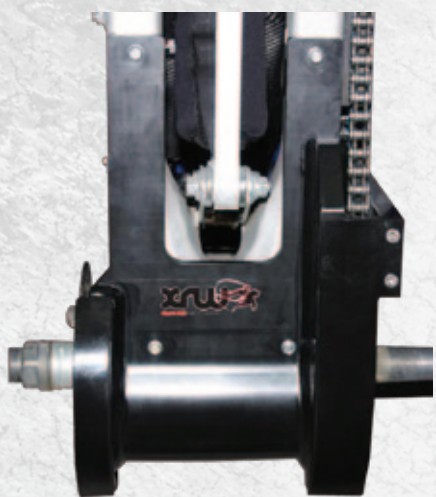
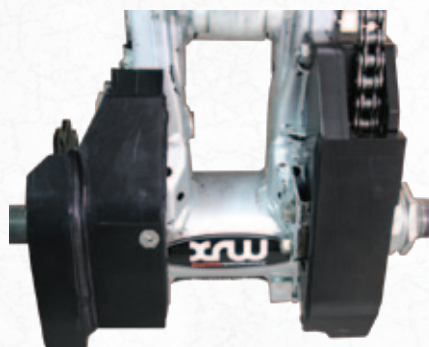
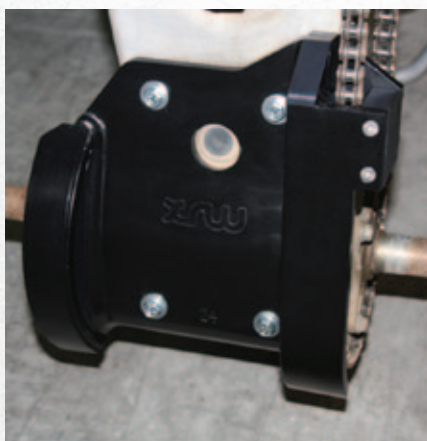

PROTEÇÃO DE BIELA PHD

PHD PROTECTION CONNECTION ROD

REF

Modelo/ Models

130101003PH

SUZUKI LTZ 400

130101503PH

SUZUKI LTZ 400 K9

Nome: Proteção de Biela PEHD

Composição: PHD 300 (Polietileno de alta densidade)

Características: Chapa (esp.) 8 mm

Name: PHD Protection Connecting Rod

Composition: PHD 300 (High density polyethylene)

Technical features: Plate (thickness) 8 mm



REF	Modelo/ Models
130050554PH	YAMAHA YFM 700 R
130051538PH	YAMAHA YFM 350 WARRIOR
130052039PH	YAMAHA 350 BANSHEE
130052544PH	YAMAHA YFM 350R
130053043PH	YAMAHA YFM 660R
130053554PH	YAMAHA YFZ 450
130054046PH	YAMAHA YFM 250 R
130054551PH	YAMAHA YFZ 450 R
130100553PH	SUZUKI LTR 450
130101053PH	SUZUKI LTZ 400
130101553PH	SUZUKI LTZ 400 K9
130150537PH	POLARIS OUTLAW 500 IRS/525 IRS
130151039PH	POLARIS OUTLAW 525 S/450 MXR
130151541PH	POLARIS PREDATOR 500
130200534NA	KIMCO KXR 250
130201036PH	KIMCO MAXXER 300
130251044PH	HONDA TRX 400 EX
130251544PH	HONDA TRX 400 EX - 2008
130252049PH	HONDA TRX 450
130252540PH	HONDA TRX 700
130300548PH	KTM 450/525 XC
130301048PH	KTM 505- 450 SX
130350534PH	ADLY 300
130351034PH	ADLY 500
130400544PH	KAWASAKI KFX 400
130401049NA	KAWASAKI KFX 450
130401538PH	KAWASAKI KFX 700
130450550PH	CAN AM DS 450EFI
130451051PH	CAN AM DS 450 XMX
130451538PH	CAN AM DS 650
130550531PH	DINLI DMX 450
130700545PH	ARTIC CAT DVX 400

Nome: Proteção Chassi PHD
 Composição: PHD 300 (Polietileno de alta densidade)
 Características: Chapa (esp.) 8 mm
 Name: Skid Plate PHD
 Composition: PHD 300 (High density polyethylene)
 Technical features: Plate (thickness) 8 mm

REF	Modelo/ Models
130050555PH	YAMAHA YFM 700 R
130051539PH	YAMAHA YFM 350 WARRIOR
130052040PH	YAMAHA 350 BANSHEE
130052545PH	YAMAHA YFM 350R
130053044PH	YAMAHA YFM 660R
130053555PH	YAMAHA YFZ 450
130054047PH	YAMAHA YFM 250 R
130054552PH	YAMAHA YFZ 450 R
130100554PH	SUZUKI LTR 450
130101054PH	SUZUKI LTZ 400
130101554PH	SUZUKI LTZ 400 K9
130150538PH	POLARIS OUTLAW 500 IRS/525 IRS
130151040PH	POLARIS OUTLAW 525 S/450 MXR
130151542PH	POLARIS PREDATOR 500
130200535NA	KIMCO KXR 250
130201037PH	KIMCO MAXXER 300
130251045PH	HONDA TRX 400 EX
130251545PH	HONDA TRX 400 EX - 2008
130252050PH	HONDA TRX 450
130252541PH	HONDA TRX 700
130252542PH	HONDA TRX 700
130300549PH	KTM 450/525 XC
130301049PH	KTM 505- 450 SX
130350535PH	ADLY 300
130351035PH	ADLY 500
130400545PH	KAWASAKI KFX 400
130401050PH	KAWASAKI KFX 450
130401539PH	KAWASAKI KFX 700
130450551PH	CAN AM DS 450EFI
130451052PH	CAN AM DS 450 XMX
130451539PH	CAN AM DS 650
130550532PH	DINLI DMX 450
130700546PH	ARTIC CAT DVX 400

Nome: Proteção Triângulos PHD
 Composição: PHD 300 (Polietileno de alta densidade)
 Características: Chapa (esp.) 6 mm
 Name: A-arms Protector PHD
 Composition: PHD 300 (High density polyethylene)
 Technical features: Plate (thickness) 6 mm

- 1 Prot. Triângulo Frente/ Front A-Arms PHD
- 2 Prot. Triângulo Trás/ Back A-Arms PHD

PROTEÇÃO CHASSI PHD

SKID PLATE PHD

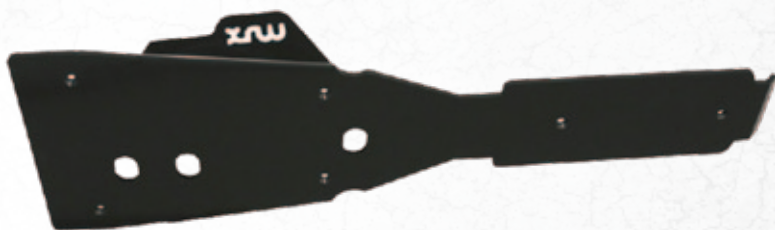

PROTEÇÃO TRIÂNGULOS PHD

A-ARMS PROTECTOR PHD





PROTEÇÕES ALUMÍNIO/ ALUMINUM PROTECTIONS

Quady Srem tel. 61 28 35 657 email: biuro@sklep-atv.pl

REF	Modelo/ Models
130050508NA	YAMAHA YFM 700 R
130052504NA	YAMAHA YFM 350R
130053509NA	YAMAHA YFZ 450-2005
130053510NA	YAMAHA YFZ 450-2006
130054005NA	YAMAHA YFM 250 R
130054508NA	YAMAHA YFZ 450 R
130100508NA	SUZUKI LTR 450
130101009NA	SUZUKI LTZ 400
130101509NA	SUZUKI LTZ 400 K9
130150504NA	POLARIS OUTLAW 500 IRS/525 IRS
130151005NA	POLARIS OUTLAW 525 S/450 MXR
130151504NA	POLARIS PREDATOR 500
130200504NA	KIMCO KXR 250
130201004NA	KIMCO MAXXER 300
130251005NA	HONDA TRX 400 EX
130251505NA	HONDA TRX 400 EX - 2008
130252008NA	HONDA TRX 450
130253004NA	HONDA TRX 300
130300506NA	KTM 450/525 XC
130301006NA	KTM 505- 450 SX
130350503NA	ADLY 300
130351003NA	ADLY 500
130400505NA	KAWASAKI KFX 400
130401007NA	KAWASAKI KFX 450
130401504NA	KAWASAKI KFX 700
130450507NA	CAN AM DS 450EFI
130451007NA	CAN AM DS 450 XMX
130451506NA	CAN AM DS 650
130550502NA	DINLI DMX 450
130700505NA	ARTIC CAT DVX 400

Nome: Proteção Disco Reforçada Alum.
Composição: Alumínio - Liga 5754 - Tratamento T5
Características: Chapa (esp.) 6 mm
* Também em versão reforçada (Liga 5083)

Name: Disc Cover Enhanced Alum.
Composition: Aluminum - Special alloy 5754 with a T5 treatment
Technical features: Plate (thickness) 6 mm
* Also version Enhanced (Special alloy 5083)

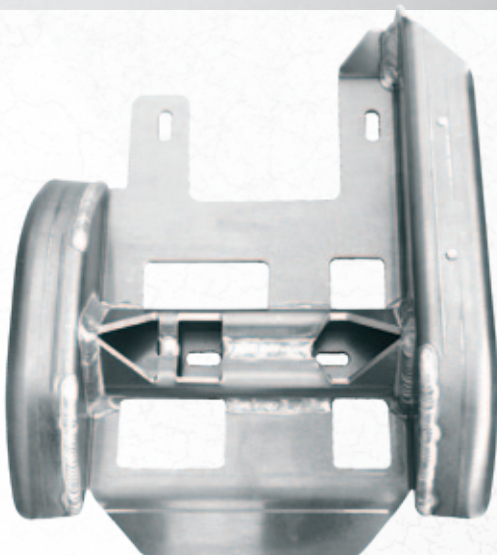

www.quadysrem.pl

REF	Modelo/ Models
130050507NA	YAMAHA YFM 700 R
130051002NA	YAMAHA YFS200 Blaster
130051503NA	YAMAHA YFM 350 WARRIOR
130052004NA	YAMAHA 350 BANSHEE
130052503NA	YAMAHA YFM 350R
130053003NA	YAMAHA YFM 660R
130053507NA	YAMAHA YFZ 450-2005
130053508NA	YAMAHA YFZ 450-2006
130054004NA	YAMAHA YFM 250 R
130054507NA	YAMAHA YFZ 450 R
130100507NA	SUZUKI LTR 450
130101008NA	SUZUKI LTZ 400
130101508NA	SUZUKI LTZ 400 K9
130150503NA	POLARIS OUTLAW 500 IRS/525 IRS
130151004NA	POLARIS OUTLAW 525 S/450 MXR
130151503NA	POLARIS PREDATOR 500
130200503NA	KIMCO KXR 250
130201003NA	KIMCO MAXXER 300
130251004NA	HONDA TRX 400 EX
130251504NA	HONDA TRX 400 EX - 2008
130252007NA	HONDA TRX 450
130253003NA	HONDA TRX 300
130300505NA	KTM 450/525 XC
130301005NA	KTM 505- 450 SX
13035002NA	ADLY 300
130351002NA	ADLY 500
130400504NA	KAWASAKI KFX 400
130401006NA	KAWASAKI KFX 450
130401503NA	KAWASAKI KFX 700
130450506NA	CAN AM DS 450EFI
130451006NA	CAN AM DS 450 XMX
130451505NA	CAN AM DS 650
130550501NA	DINLI DMX 450
130700504NA	ARTIC CAT DVX 400

Nome: Proteção Disco Alum.
Composição: Alumínio - Liga 5754 - Tratamento T5
Características: Chapa (esp.) 6 mm
* Também em versão reforçada (Liga 5083)

Name: Disc Cover Alum.
Composition: Aluminum - Special alloy 5754 with a T5 treatment
Technical features: Plate (thickness) 6 mm
* Also version Enhanced (Special alloy 5083)

PROTEÇÃO DISCO ALUM.
DISC COVER ALUM.

www.sklep-atv.pl

www.centrum-brp.pl

PROTEÇÃO FRONTAL FRONT GUARD

Quady Śrem tel. 61 28 35 657 email: biuro@sklep-atv.pl

REF	Modelo/ Models
130050536PR	YAMAHA YFM 700 R
130050536NA	YAMAHA YFM 700 R
130050537NA	YAMAHA YFM 700 R
130052531NA	YAMAHA YFM 350R
130052531PR	YAMAHA YFM 350R
130053030NA	YAMAHA YFM 660R
130053030PR	YAMAHA YFM 660R
130053538NA	YAMAHA YFZ 450
130053538PR	YAMAHA YFZ 450
130054031NA	YAMAHA YFM 250 R
130054031PR	YAMAHA YFM 250 R
130100536PR	SUZUKI LTR 450
130100536NA	SUZUKI LTR 450
130101037PR	SUZUKI LTZ 400
130101037NA	SUZUKI LTZ 400
130101537PR	SUZUKI LTZ 400 K9
130101537NA	SUZUKI LTZ 400 K9
130151529PR	POLARIS PREDATOR 500
130151529NA	POLARIS PREDATOR 500
130251032PR	HONDA TRX 400 EX
130251032NA	HONDA TRX 400 EX
130251532PR	HONDA TRX 400 EX - 2008
130251532NA	HONDA TRX 400 EX - 2008
130252035PR	HONDA TRX 450
130252035NA	HONDA TRX 450
130300534PR	KTM 450/525 XC
130300534NA	KTM 450/525 XC
130301034PR	KTM 505- 450 SX
130301034NA	KTM 505- 450 SX
130400532PR	KAWASAKI KFX 400
130400532NA	KAWASAKI KFX 400
130450535PR	CAN AM DS 450EFI
130450535NA	CAN AM DS 450EFI
130451035PR	CAN AM DS 450 XMX
130451035NA	CAN AM DS 450 XMX
130451036NA	CAN AM DS 450 XMX
130700532PR	ARTIC CAT DVX 400
130700532NA	ARTIC CAT DVX 400

Nome: Proteção Frontal
Composição: Alumínio - Liga 5754 - Tratamento T5
Características: Chapa (esp.) 2.5 mm

Name: Front Guard
Composition: Aluminum - Special alloy 5754 with a T5 treatment
Technical features: Plate (thickness) 2.5 mm

1 Prot. Radiador/ Radiator Protection

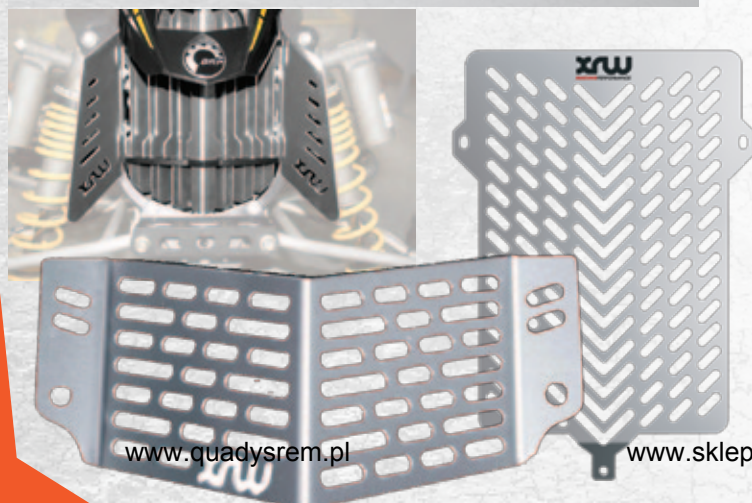

www.quadysrem.pl

www.sklep-atv.pl

PROTEÇÃO LATERAL QUADRO FRAME GUARD

REF	Modelo/ Models
130050510NA	YAMAHA YFM 700 R
130050510PR	YAMAHA YFM 700 R
130052005NA	YAMAHA 350 BANSHEE
130052005PR	YAMAHA 350 BANSHEE
130052505PR	YAMAHA YFM 350R
130052505NA	YAMAHA YFM 350R
130053004PR	YAMAHA YFM 660R
130053004NA	YAMAHA YFM 660R
130053512PR	YAMAHA YFZ 450
130053512NA	YAMAHA YFZ 450
130054006PR	YAMAHA YFM 250 R
130054006NA	YAMAHA YFM 250 R
130054510PR	YAMAHA YFZ 450 R
130054510NA	YAMAHA YFZ 450 R
130100510PR	SUZUKI LTR 450
130100510NA	SUZUKI LTR 450
130101011PR	SUZUKI LTZ 400
130101011NA	SUZUKI LTZ 400
130101511PR	SUZUKI LTZ 400 K9
130101511NA	SUZUKI LTZ 400 K9
130251006PR	HONDA TRX 400 EX
130251006NA	HONDA TRX 400 EX
130251506PR	HONDA TRX 400 EX - 2008
130251506NA	HONDA TRX 400 EX - 2008
130252009PR	HONDA TRX 450
130252009NA	HONDA TRX 450
130300508PR	KTM 450/525 XC
130300508NA	KTM 450/525 XC
130301008PR	KTM 505- 450 SX
130301008NA	KTM 505- 450 SX
130400506PR	KAWASAKI KFX 400
130400506NA	KAWASAKI KFX 400
130401009PR	KAWASAKI KFX 450
130401009NA	KAWASAKI KFX 450
130450509PR	CAN AM DS 450EFI
130450509NA	CAN AM DS 450EFI
130451009PR	CAN AM DS 450 XMX
130451009NA	CAN AM DS 450 XMX
130700506PR	ARTIC CAT DVX 400
130700506NA	ARTIC CAT DVX 400

Nome: Proteção Lateral Quadro
Composição: Alumínio - Liga 5754 - Tratamento T5
Características: Chapa (esp.) 2.5 mm

Name: Frame Guard
Composition: Aluminum - Special alloy 5754 with a T5 treatment
Technical features: Plate (thickness) 2.5 mm

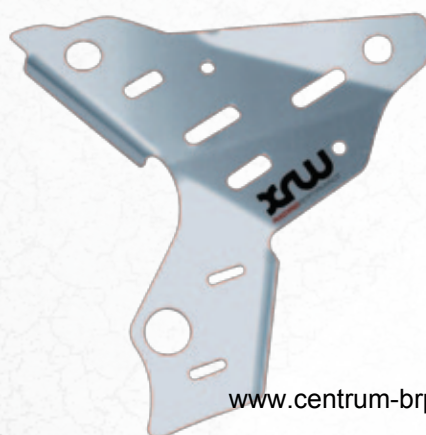

www.centrum-brp.pl

REF	Modelo/ Models	Espeçura/ Thickness
130050550NA	YAMAHA YFM 700 R	3mm
130050551NA	YAMAHA YFM 700 R	4mm
130050552NA	YAMAHA YFM 700 R	5mm
130051029NA	YAMAHA YFS200 Blaster	3mm
130051030NA	YAMAHA YFS200 Blaster	4mm
130051031NA	YAMAHA YFS200 Blaster	5mm
130051534NA	YAMAHA YFM 350 WARRIOR	3mm
130051535NA	YAMAHA YFM 350 WARRIOR	4mm
130051536NA	YAMAHA YFM 350 WARRIOR	5mm
130052035NA	YAMAHA 350 BANSHEE	3mm
130052036NA	YAMAHA 350 BANSHEE	4mm
130052037NA	YAMAHA 350 BANSHEE	5mm
130052540NA	YAMAHA YFM 350R	3mm
130052541NA	YAMAHA YFM 350R	4mm
130052542NA	YAMAHA YFM 350R	5mm
130053039NA	YAMAHA YFM 660R	3mm
130053040NA	YAMAHA YFM 660R	4mm
130053041NA	YAMAHA YFM 660R	5mm
130053550NA	YAMAHA YFZ 450	3mm
130053551NA	YAMAHA YFZ 450	4mm
130053552NA	YAMAHA YFZ 450	5mm
130054042NA	YAMAHA YFM 250 R	3mm
130054043NA	YAMAHA YFM 250 R	4mm
130054044NA	YAMAHA YFM 250 R	5mm
130054547NA	YAMAHA YFZ 450 R	3mm
130054548NA	YAMAHA YFZ 450 R	4mm
130054549NA	YAMAHA YFZ 450 R	5mm
130100549NA	SUZUKI LTR 450	3mm
130100550NA	SUZUKI LTR 450	4mm
130100551NA	SUZUKI LTR 450	5mm
130101049NA	SUZUKI LTZ 400	3mm
130101050NA	SUZUKI LTZ 400	4mm
130101051NA	SUZUKI LTZ 400	5mm
130101549NA	SUZUKI LTZ 400 K9	3mm
130101550NA	SUZUKI LTZ 400 K9	4mm
130101551NA	SUZUKI LTZ 400 K9	5mm
130150533NA	POLARIS OUTLAW 500 IRS/525 IRS	3mm
130150534NA	POLARIS OUTLAW 500 IRS/525 IRS	4mm
130150535NA	POLARIS OUTLAW 500 IRS/525 IRS	5mm
130151035NA	POLARIS OUTLAW 525 S/450 MXR	3mm
130151036NA	POLARIS OUTLAW 525 S/450 MXR	4mm
130151037NA	POLARIS OUTLAW 525 S/450 MXR	5mm
130151537NA	POLARIS PREDATOR 500	3mm
130151538NA	POLARIS PREDATOR 500	4mm
130151539NA	POLARIS PREDATOR 500	5mm
130200532NA	KIMCO KXR 250	3mm
130200532NA	KIMCO KXR 250	4mm
130200533NA	KIMCO KXR 250	5mm
130201032NA	KIMCO MAXXER 300	3mm
130201033NA	KIMCO MAXXER 300	4mm
130201034NA	KIMCO MAXXER 300	5mm
130251040NA	HONDA TRX 400 EX	3mm
130251041NA	HONDA TRX 400 EX	4mm
130251042NA	HONDA TRX 400 EX	5mm
130251540NA	HONDA TRX 400 EX - 2008	3mm
130251541NA	HONDA TRX 400 EX - 2008	4mm
130251542NA	HONDA TRX 400 EX - 2008	5mm
130252045NA	HONDA TRX 450	3mm
130252046NA	HONDA TRX 450	4mm
130252047NA	HONDA TRX 450	5mm

www.quadysrem.pl

Quady Śrem tel. 6 28 35 657 email: biuro@sklepatv.pl

REF	Modelo/ Models	Espeçura/ Thickness
130252535NA	HONDA TRX 700	3mm
130252536NA	HONDA TRX 700	4mm
130252537NA	HONDA TRX 700	5mm
130253032NA	HONDA TRX 300	3mm
130253033NA	HONDA TRX 300	4mm
130253034NA	HONDA TRX 300	5mm
130300544NA	KTM 450/525 XC	3mm
130300545NA	KTM 450/525 XC	4mm
130300546NA	KTM 450/525 XC	5mm
130301044NA	KTM 505- 450 SX	3mm
130301045NA	KTM 505- 450 SX	4mm
130301046NA	KTM 505- 450 SX	5mm
130350530NA	ADLY 300	3mm
130350531NA	ADLY 300	4mm
130350532NA	ADLY 300	5mm
130351030NA	ADLY 500	3mm
130351031NA	ADLY 500	4mm
130351032NA	ADLY 500	5mm
130400540NA	KAWASAKI KFX 400	3mm
130400541NA	KAWASAKI KFX 400	4mm
130400542NA	KAWASAKI KFX 400	5mm
130401045NA	KAWASAKI KFX 450	3mm
130401046NA	KAWASAKI KFX 450	4mm
130401047NA	KAWASAKI KFX 450	5mm
130401534NA	KAWASAKI KFX 700	3mm
130401535NA	KAWASAKI KFX 700	4mm
130401536NA	KAWASAKI KFX 700	5mm
130450546NA	CAN AM DS 450EFI	3mm
130450547NA	CAN AM DS 450EFI	4mm
130450548NA	CAN AM DS 450EFI	5mm
130451047NA	CAN AM DS 450 XMX	3mm
130451048NA	CAN AM DS 450 XMX	4mm
130451049NA	CAN AM DS 450 XMX	5mm
130451534NA	CAN AM DS 650	3mm
130451535NA	CAN AM DS 650	4mm
130451536NA	CAN AM DS 650	5mm
130550527NA	DINLI DMX 450	3mm
130550528NA	DINLI DMX 450	4mm
130550529NA	DINLI DMX 450	5mm
130700541NA	ARTIC CAT DVX 400	3mm
130700542NA	ARTIC CAT DVX 400	4mm
130700543NA	ARTIC CAT DVX 400	5mm

Nome: Proteção Chassi

Composição: Alumínio - Liga 5754 - Tratamento T5

Características: Chapa (esp.) 3 mm / 4mm / 5mm

Name: Skid Plate

Composition: Aluminum - Special alloy 5754 with a T5 treatment

Technical features: Plate (thickness) 3 mm / 4mm / 5mm

PROTEÇÃO CHASSI SKID PLATE



www.sklep-atv.pl

www.centrum-brp.pl

PROTEÇÃO TRIÂNGULOS

A-ARMS PROTECTOR

REF	Modelo/ Models	
130050553NA	YAMAHA YFM 700 R	
130051032NA	YAMAHA YFS200 Blaster	
130051537NA	YAMAHA YFM 350 WARRIOR	
130052038NA	YAMAHA 350 BANSHEE	
130052543NA	YAMAHA YFM 350R	
130053042NA	YAMAHA YFM 660R	
130053553NA	YAMAHA YFZ 450	
130054045NA	YAMAHA YFM 250 R	
130054550NA	YAMAHA YFZ 450 R	
130100552NA	SUZUKI LTR 450	
130101052NA	SUZUKI LTZ 400	
130101552NA	SUZUKI LTZ 400 K9	
130150536NA	POLARIS OUTLAW 500 IRS/525 IRS	
130151038NA	POLARIS OUTLAW 525 S/450 MXR	
130151540NA	POLARIS PREDATOR 500	
130200533NA	KIMCO KXR 250	1
130201035NA	KIMCO MAXXER 300	2
130251043NA	HONDA TRX 400 EX	
130251543NA	HONDA TRX 400 EX - 2008	
130252048NA	HONDA TRX 450	
130252538NA	HONDA TRX 700	
130252539NA	HONDA TRX 700	
130300547NA	KTM 450/525 XC	
130301047NA	KTM 505- 450 SX	
130350533NA	ADLY 300	
130351033NA	ADLY 500	
130400543NA	KAWASAKI KFX 400	
130401048NA	KAWASAKI KFX 450	
130401537NA	KAWASAKI KFX 700	
130450549NA	CAN AM DS 450EFI	
130451050NA	CAN AM DS 450 XMX	
130451537NA	CAN AM DS 650	
130550530NA	DINLI DMX 450	
130700544NA	ARTIC CAT DVX 400	

Nome: Proteção Triângulo

Composição: Alumínio - Liga 5754 - Tratamento T5

Características: Chapa (esp.) 3 mm

Name: Protection A-arms

Composition: Aluminum - Special alloy 5754 with a T5 treatment

Technical features: Plate (thickness) 3 mm

1 Prot. Triângulo Frente/ Front A-Arms Alum

2 Prot. Triângulo Trás/ Back A-Arms Alum

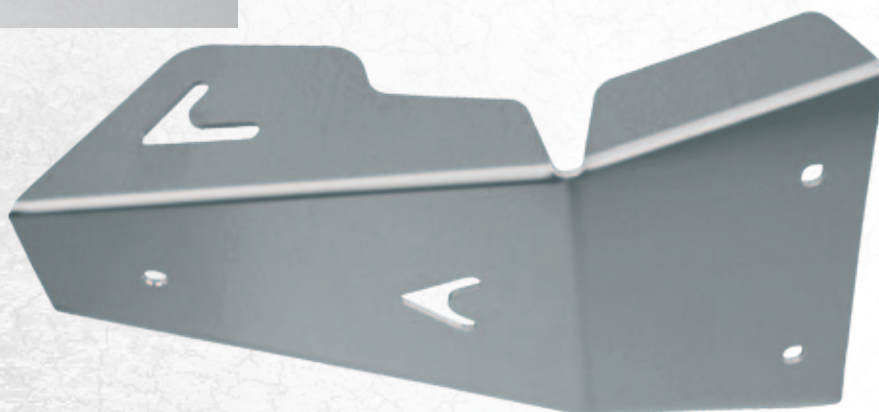



Acessórios

REF	Nome/ Name
160PATIMUNI	Patim Universal/ Fat Pegs - Universal

Nome: Patim Universal
 Composição: Aço
 Características: Chapa (esp.) 4 mm

Name: Fat Peg Universal
 Composition: Iron
 Technical features: Plate (thickness) 4 mm



REF	Nome/ Name
160CAVFLEXS	Cavalete Flexível Alumínio/ Alum. Flexible Stand - 500mm
160CAVFLEXL	Cavalete Flexível Longo/ Long Alum. Flexible Stand - 650mm

Nome: Cavalete Alumínio Flexível
 Composição: Alumínio - Liga 6060 - Tratamento T5
 Características: Tubo Ø 35x2.5

Name: Alum. Flexible Stand
 Composition: Aluminum - Special alloy 6060 with a T5 treatment
 Technical features: Pipe Ø 35 x 2.5

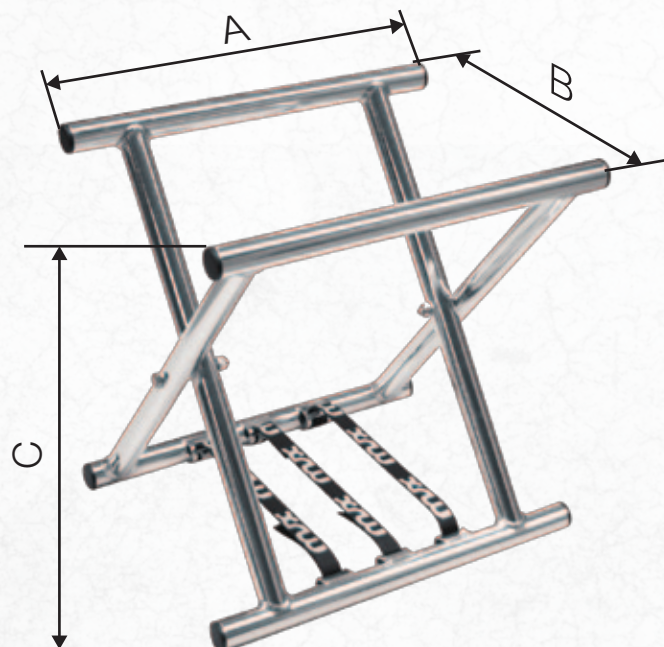

CAVALETE STANDARD	CAVALETE LONGO
ALTURA (C) : 500mm	ALTURA (C) : 650mm
LARGURA (A): 490cm	LARGURA (A): 490cm
LARGURA (B): 430cm	LARGURA (B): 480cm

CAVALETE FRENTE STAND FRONT



CAVALETE TRÁS STAND REAR

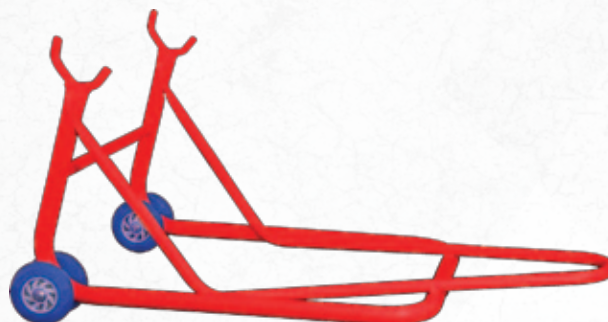

REF	Nome/ Name
260CAVALEFR	Cavalete Quad Frente/ Quad Stand Front
260CAVALETR	Cavalete Quad Trás/ Quad Stand Back

Nome: Cavalete Elevação (Frente e Trás) - Quad

Name: Stand Quad (Front and Back) - Quad

PEGA TRASEIRA "TIPO ORIGINAL"

Quady Srem tel. 61 28 35 657 email: biuro@sklepatv.pl

GRAB BAR "ORIGINAL TYPE"

REF	Modelo/ Models	
130050538PO	YAMAHA YFM 700 R	■
130050538PR	YAMAHA YFM 700 R	■
130051529PR	YAMAHA YFM 350 WARRIOR	■
130051529PO	YAMAHA YFM 350 WARRIOR	■
130052041PO	YAMAHA 350 BANSHEE	■
130052041PR	YAMAHA 350 BANSHEE	■
130052532PO	YAMAHA YFM 350R	■
130052532PR	YAMAHA YFM 350R	■
130053031PO	YAMAHA YFM 660R	■
130053031PR	YAMAHA YFM 660R	■
130053539PO	YAMAHA YFZ 450	■
130053539PR	YAMAHA YFZ 450	■
130054032PO	YAMAHA YFM 250 R	■
130054032PR	YAMAHA YFM 250 R	■
130054536PO	YAMAHA YFZ 450 R	■
130054536PR	YAMAHA YFZ 450 R	■
130100537PO	SUZUKI LTR 450	■
130100537PR	SUZUKI LTR 450	■
130101038PO	SUZUKI LTZ 400	■
130101038PR	SUZUKI LTZ 400	■
130101538PO	SUZUKI LTZ 400 K9	■
130101538PR	SUZUKI LTZ 400 K9	■
130150529PO	POLARIS OUTLAW 500 IRS/525 IRS	■
130150529PR	POLARIS OUTLAW 500 IRS/525 IRS	■
130151030PO	POLARIS OUTLAW 525 S/450 MXR	■
130151030PR	POLARIS OUTLAW 525 S/450 MXR	■
130151530PO	POLARIS PREDATOR 500	■
130151530PR	POLARIS PREDATOR 500	■
130200531PR	KIMCO KXR 250	■
130200531PO	KIMCO KXR 250	■
130201031PR	KIMCO MAXXER 300	■
130201031PO	KIMCO MAXXER 300	■
130251039PR	HONDA TRX 400 EX	■
130251039PO	HONDA TRX 400 EX	■
130251539PR	HONDA TRX 400 EX - 2008	■
130251539PO	HONDA TRX 400 EX - 2008	■
130252036PO	HONDA TRX 450	■
130252036PR	HONDA TRX 450	■
130252529PO	HONDA TRX 700	■
130252529PR	HONDA TRX 700	■
130300535PO	KTM 450/525 XC	■
130300535PR	KTM 450/525 XC	■
130301035PO	KTM 505- 450 SX	■
130301035PR	KTM 505- 450 SX	■
130401034PR	KAWASAKI KFX 450	■
130401034PO	KAWASAKI KFX 450	■
130450536PO	CAN AM DS 450EFI	■
130450536PR	CAN AM DS 450EFI	■
130451037PO	CAN AM DS 450 XMX	■
130451037PR	CAN AM DS 450 XMX	■
130700533PR	ARTIC CAT DVX 400	■
130700533PO	ARTIC CAT DVX 400	■

Nome: Pega Traseira "Tipo Original"
Composição: Alumínio - Liga 6060 - Tratamento T5
Características: Tubo Ø 27 x 3

Name: Grab Bar "Original Type"
Composition: Aluminum - Special alloy 6060 with a T5 treatment
Technical features: Pipe Ø 27 x 3



www.quadysrem.pl

PEGA TRASEIRA "RACING"

GRAB BAR "RACING"

REF	Modelo/ Models	
130100538PR	SUZUKI LTR 450	■
130100538PO	SUZUKI LTR 450	■
130101039PR	SUZUKI LTZ 400	■
130101039PO	SUZUKI LTZ 400	■
130101539PR	SUZUKI LTZ 400 K9	■
130101539PO	SUZUKI LTZ 400 K9	■
130151031PR	POLARIS OUTLAW 525 S/450 MXR	■
130151031PO	POLARIS OUTLAW 525 S/450 MXR	■
130301036PR	KTM 505- 450 SX	■
130301036PO	KTM 505- 450 SX	■
130401035PR	KAWASAKI KFX 450	■
130401035PO	KAWASAKI KFX 450	■
130450537PR	CAN AM DS 450EFI	■
130450537PO	CAN AM DS 450EFI	■
130451038PR	CAN AM DS 450 XMX	■
130451038PO	CAN AM DS 450 XMX	■

Nome: Pega Traseira "Racing"
Composição: Alumínio - Liga 6060 - Tratamento T5
Características: Tubo Ø 27 x 3

Name: Grab Bar "Racing"
Composition: Aluminum - Special alloy 6060 with a T5 treatment
Technical features: Pipe Ø 27 x 3



www.sklep-atv.pl

www.centrum-brp.pl

SUPOORTE TRASEIRO COM BOLSA PACK RACK

REF	Modelo/ Models	
130050548PR	YAMAHA YFM 700 R	■
130050548PO	YAMAHA YFM 700 R	■
130050549PR	YAMAHA YFM 700 R	■
130050549PO	YAMAHA YFM 700 R	■
130052539PR	YAMAHA YFM 350R	■
130052539PO	YAMAHA YFM 350R	■
130053038PR	YAMAHA YFM 660R	■
130053038PO	YAMAHA YFM 660R	■
130053549PR	YAMAHA YFZ 450	■
130053549PO	YAMAHA YFZ 450	■
130054040PR	YAMAHA YFM 250 R	■
130054041PO	YAMAHA YFM 250 R	■
130054546PR	YAMAHA YFZ 450 R	■
130054546PO	YAMAHA YFZ 450 R	■
130100548PR	SUZUKI LTR 450	■
130100548PO	SUZUKI LTR 450	■
130101048PR	SUZUKI LTZ 400	■
130101048PO	SUZUKI LTZ 400	■
130101548PR	SUZUKI LTZ 400 K9	■
130101548PO	SUZUKI LTZ 400 K9	■
130151536PR	POLARIS PREDATOR 500	■
130151536PO	POLARIS PREDATOR 500	■
130252044PR	HONDA TRX 450	■
130252044PO	HONDA TRX 450	■
130300536PR	KTM 450/525 XC	■
130300536PO	KTM 450/525 XC	■
130350529PR	ADLY 300	■
130350529PO	ADLY 300	■
130351029PR	ADLY 500	■
130351029PO	ADLY 500	■
130400539PR	KAWASAKI KFX 400	■
130400539PO	KAWASAKI KFX 400	■
130401044PR	KAWASAKI KFX 450	■
130401044PO	KAWASAKI KFX 450	■
130401533PR	KAWASAKI KFX 700	■
130401533PO	KAWASAKI KFX 700	■
130450545PR	CAN AM DS 450EFI	■
130450545PO	CAN AM DS 450EFI	■
130451046PR	CAN AM DS 450 XMX	■
130451046PO	CAN AM DS 450 XMX	■
130451533PR	CAN AM DS 650	■
130451533PO	CAN AM DS 650	■
130700540PR	ARTIC CAT DVX 400	■
130700540PO	ARTIC CAT DVX 400	■

Nome: Suporte Traseiro com Bolsa
Composição: Alumínio - Liga 6060 - Tratamento T5
Características: Tubo Ø 35 x 2.5

Name: Pack Rack
Composition: Aluminum - Special alloy 6060 with a T5 treatment
Technical features: Pipe Ø 35 x 2.5



www.quadysrem.pl

PROTEÇÕES FAROL LIGHT PROTECTION

REF	Modelo/ Models	
25501LTZ4PR	SUZUKI LTZ 400	■
25501LTZ4PO	SUZUKI LTZ 400	■
25502LTR4PR	SUZUKI LTR 450	■
25502LTR4PO	SUZUKI LTR 450	■
25503LTZ4PR	SUZUKI LTZ 400 K9	■
25503LTZ4PO	SUZUKI LTZ 400 K9	■
25504YFZ4PR	YAMAHA YFZ 450	■
25504YFZ4PO	YAMAHA YFZ 450	■
25505YFM3PR	YAMAHA YFM 350R	■
25505YFM3PO	YAMAHA YFM 350R	■
25506YFM7PR	YAMAHA YFM 700 R	■
25506YFM7PO	YAMAHA YFM 700 R	■
25507YFZ4PR	YAMAHA YFZ 450 R	■
25507YFZ4PO	YAMAHA YFZ 450 R	■
25508YFM6PR	YAMAHA YFM 660R	■
25508YFM6PO	YAMAHA YFM 660R	■
25509WAR3PR	YAMAHA YFM 350 WARRIOR	■
25509WAR3PO	YAMAHA YFM 350 WARRIOR	■
25510YFM2PR	YAMAHA YFM 250 R	■
25510YFM2PO	YAMAHA YFM 250 R	■

Nome: Proteções Farol

Name: Light Protection

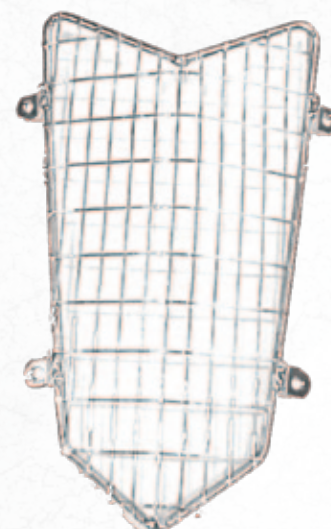
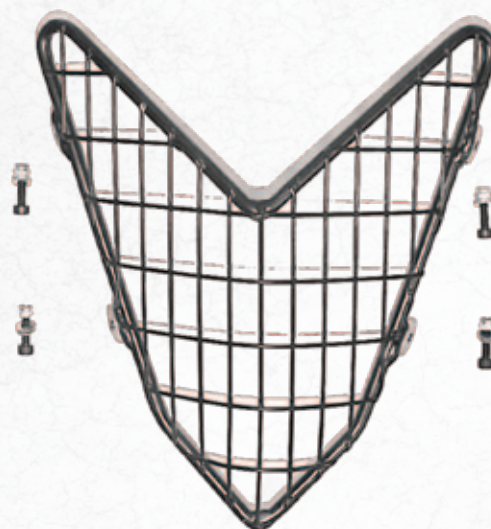

www.sklep-atv.pl

www.centrum-brp.pl

ALARGADOR ALUM. WHEEL SPACER ALUM.



REF	Descrição/ Description
150A454110T	ALARGADORES RODA TRÁS/BACK EXTENDERS Ø110/ Ø115
150A454144F	ALARGADORES RODA FRENTE/FRONT EXTENDERS Ø144/ Ø156
150A454110P	ALARGADORES RODA TRÁS/BACK EXTENDERS Ø110/ Ø115- POLARIS
150A454156P	ALARGADORES RODA FRENTE/FRONT EXTENDERS Ø156 - POLARIS
150A454136T	ALARGADOR/EXTENDERS Ø 136(KFX700/CAN AM RENEGADE)
150A454100T	ALARGADOR/EXTENDERS Ø100/ Ø115 MM - Blaster
150A454100S	ALARGADOR/EXTENDERS SCRAMBLER 500
150A454144C	ALARGADOR FR/FRONT EXTENDERS CANAM DS 450/DS 650
150A454110C	ALARGADOR TRÁS/BACK EXTENDERS CANAM DS 450/DS 650
150A354110T	ALARGADORES RODA TRÁS/BACK EXTENDERS Ø110/ Ø115 - 35mm
150A354144F	ALARGADORES RODA FRENTE/FRONT EXTENDERS Ø144/ Ø156- 35mm
150M1012545	PERNOS DE ALARGADOR/BOLTS EXTENDERS (M10x1,25)
150M1015045	PERNOS DE ALARGADOR/BOLTS EXTENDERS CANAM (M10x1,5)
15038POLA45	PERNOS DE ALARGADOR POLARIS/BOLTS EXTENDERS POLARIS
150M1012535	PERNOS DE ALARGADOR 35mm/BOLTS EXTENDERS (M10x1,25)

Nome: Alargador Alum

Cada Kit é composto por 2 alargadores e 8 pernos

Características: Espessuras existentes 45mm e 35mm
 Para todos os QUADS / ATV e UTV (sob consulta)

Name: Wheel Spacer Alum

Each Kit contains 2 Wheel Spacers and 8 bolts

Technical features: Existing thicknesses 45mm and 35mm
 For all QUADS / ATV and UTV (on request)

ALARGADOR POLYAMIDE WHEEL SPACER POLYAMIDE



REF	Descrição/ Description
150A454144B	ALARGADOR POLYAMIDE FR/FRONT EXTENDERS POLYAMIDE (BLACK) - Ø156
150A454110B	ALARGADOR POLYAMIDE TRÁS/BACK EXTENDERS POLYAMIDE (BLACK)- Ø115
150A454144R	ALARGADOR POLYAMIDE FR VER/FRONT EXTENDERS POLYAMIDE RED - Ø156
150A454110R	ALARGADOR TRÁS POLYAMIDE VER/BACK EXTENDERS POLYAMIDE RED - Ø115
150A454144L	ALARGADOR FR POLYAMIDE AZUL/FRONT EXTENDERS POLYAMIDE BLUE - Ø156
150A454110L	ALARGADOR TRÁS POLYAMIDE AZUL/BACK EXTENDERS POLYAMIDE BLUE - Ø115

Nome: Alargador Polyamide

Cada Kit é composto por 2 alargadores e 8 pernos

Características: Espessuras existentes 45mm e 35mm
 Para todos os QUADS / ATV e UTV (sob consulta)

Name: Wheel Spacer Polyamide

Each Kit contains 2 Wheel Spacers and 8 bolts

Technical features: Existing thicknesses 45mm and 35mm
 For all QUADS / ATV and UTV (on request)

REF	Modelo/ Models	
130050503FP	YAMAHA YFM 700 R	●
130050503CO	YAMAHA YFM 700 R	●
130051001FP	YAMAHA YFS200 Blaster	●
130051001CO	YAMAHA YFS200 Blaster	●
130051501FP	YAMAHA YFM 350 WARRIOR	●
130051501CO	YAMAHA YFM 350 WARRIOR	●
130052001FP	YAMAHA 350 BANSHEE	●
130052001CO	YAMAHA 350 BANSHEE	●
130052501FP	YAMAHA YFM 350R	●
130052501CO	YAMAHA YFM 350R	●
130053001FP	YAMAHA YFM 660R	●
130053001CO	YAMAHA YFM 660R	●
130053503FP	YAMAHA YFZ 450	●
130053503CO	YAMAHA YFZ 450	●
130054002FP	YAMAHA YFM 250 R	●
130054002CO	YAMAHA YFM 250 R	●
130054503FP	YAMAHA YFZ 450 R	●
130054503CO	YAMAHA YFZ 450 R	●
130100503FP	SUZUKI LTR 450	●
130100503CO	SUZUKI LTR 450	●
130101004FP	SUZUKI LTZ 400	●
130101004CO	SUZUKI LTZ 400	●
130101504FP	SUZUKI LTZ 400 K9	●
130101504CO	SUZUKI LTZ 400 K9	●
130102001FP	SUZUKI LTZ 250	●
130102001CO	SUZUKI LTZ 250	●
130150501FP	POLARIS OUTLAW 500 IRS/525 IRS	●
130150501CO	POLARIS OUTLAW 500 IRS/525 IRS	●
130151002FP	POLARIS OUTLAW 525 S/450 MXR	●
130151002CO	POLARIS OUTLAW 525 S/450 MXR	●
130151501FP	POLARIS PREDATOR 500	●
130151501CO	POLARIS PREDATOR 500	●
130200501FP	KIMCO KXR 250	●
130200501CO	KIMCO KXR 250	●
130201001FP	KIMCO MAXXER 300	●
130201001CO	KIMCO MAXXER 300	●
130250501FP	HONDA TRX 250 EX	●
130250501CO	HONDA TRX 250 EX	●
130251002FP	HONDA TRX 400 EX	●
130251002CO	HONDA TRX 400 EX	●
130251502FP	HONDA TRX 400 EX - 2008	●
130251502CO	HONDA TRX 400 EX - 2008	●
130252003FP	HONDA TRX 450	●
130252003CO	HONDA TRX 450	●
130252501FP	HONDA TRX 700	●
130252501CO	HONDA TRX 700	●
130253001FP	HONDA TRX 300	●
130253001CO	HONDA TRX 300	●
130300503FP	KTM 450/525 XC	●
130300503CO	KTM 450/525 XC	●
130301003FP	KTM 505- 450 SX	●
130301003CO	KTM 505- 450 SX	●
130350501FP	ADLY 300	●
130350501CO	ADLY 300	●
130351001FP	ADLY 500	●
130351001CO	ADLY 500	●
130400502FP	KAWASAKI KFX 400	●
130400502CO	KAWASAKI KFX 400	●
130401002FP	KAWASAKI KFX 450	●
130401002CO	KAWASAKI KFX 450	●
130401501FP	KAWASAKI KFX 700	●
130401501CO	KAWASAKI KFX 700	●
130450503FP	CAN AM DS 450EFI	●
130450503CO	CAN AM DS 450EFI	●
130451003FP	CAN AM DS 450 XMX	●

Nome: Correias Nerf Bar Basic
 Composição: Tecidas em Polipropileno
 Características: Diversa cores/ XRW branco ou vermelho

Name: Belt Ner Bar Basic
 Composition: Woven in polypropylene
 Technical features: Several colors/ XRW white or red

- - Basic (Preto / Black)
- - Color

Cores existentes: Vermelho/ Azul/ Amarelo/ Verde/ Laranja
 Available color: Red/ Bleu/ yellow/ Green/ Orange

CORREIAS NERF BAR BASIC BELT NER BAR BASIC



CORREIAS NERF BAR R1
BELT NER BAR R1



REF	Modelo/ Models	
130050505FP	YAMAHA YFM 700 R	●
130050505CO	YAMAHA YFM 700 R	●
130051502FP	YAMAHA YFM 350 WARRIOR	●
130051502CO	YAMAHA YFM 350 WARRIOR	●
130052003FP	YAMAHA 350 BANSHEE	●
130052003CO	YAMAHA 350 BANSHEE	●
130052502FP	YAMAHA YFM 350R	●
130052502CO	YAMAHA YFM 350R	●
130053002FP	YAMAHA YFM 660R	●
130053002CO	YAMAHA YFM 660R	●
130053505FP	YAMAHA YFZ 450	●
130053505CO	YAMAHA YFZ 450	●
130054003FP	YAMAHA YFM 250 R	●
130054003CO	YAMAHA YFM 250 R	●
130054505FP	YAMAHA YFZ 450 R	●
130054505CO	YAMAHA YFZ 450 R	●
130100505FP	SUZUKI LTR 450	●
130100505CO	SUZUKI LTR 450	●
130101006FP	SUZUKI LTZ 400	●
130101006CO	SUZUKI LTZ 400	●
130101506FP	SUZUKI LTZ 400 K9	●
130101506CO	SUZUKI LTZ 400 K9	●
130150502FP	POLARIS OUTLAW 500 IRS/525 IRS	●
130150502CO	POLARIS OUTLAW 500 IRS/525 IRS	●
130151003FP	POLARIS OUTLAW 525 S/450 MXR	●
130151003CO	POLARIS OUTLAW 525 S/450 MXR	●
130151502FP	POLARIS PREDATOR 500	●
130151502CO	POLARIS PREDATOR 500	●
130200502FP	KIMCO KXR 250	●
130200502CO	KIMCO KXR 250	●
130201002FP	KIMCO MAXXER 300	●
130201002CO	KIMCO MAXXER 300	●
130251003FP	HONDA TRX 400 EX	●
130251003CO	HONDA TRX 400 EX	●
130251503FP	HONDA TRX 400 EX - 2008	●
130251503CO	HONDA TRX 400 EX - 2008	●
130252005FP	HONDA TRX 450	●
130252005CO	HONDA TRX 450	●
130252503FP	HONDA TRX 700	●
130252503CO	HONDA TRX 700	●
130253002FP	HONDA TRX 300	●
130253002CO	HONDA TRX 300	●
130300504FP	KTM 450/525 XC	●
130300504CO	KTM 450/525 XC	●
130301004FP	KTM 505- 450 SX	●
130301004CO	KTM 505- 450 SX	●
130400503FP	KAWASAKI KFX 400	●
130400503CO	KAWASAKI KFX 400	●
130401003FP	KAWASAKI KFX 450	●
130401003CO	KAWASAKI KFX 450	●
130401502FP	KAWASAKI KFX 700	●
130401502CO	KAWASAKI KFX 700	●
130450505FP	CAN AM DS 450EFI	●
130450505CO	CAN AM DS 450EFI	●
130451005FP	CAN AM DS 450 XMX	●
130451005CO	CAN AM DS 450 XMX	●
130650501FP	AEON COBRA 350	●
130650501CO	AEON COBRA 350	●
130700503FP	ARTIC CAT DVX 400	●
130700503CO	ARTIC CAT DVX 400	●

Nome: Correias Nerf Bar R1
Composição: Tecidas em Polipropileno
Características: Diversa cores/ XRW branco ou vermelho

Name: Belt Ner Bar R1
Composition: Woven in polypropylene
Technical features: Several colors/ XRW white or red

- - Basic
- - Color

Cores existentes: Vermelho/ Azul/ Amarelo/ Verde/ Laranja
Available color: Red/ Bleu/ Yellow/ Green/ Orange

CORREIAS NERF BAR Q1 E Q2

BELT NER BAR Q1 AND Q2

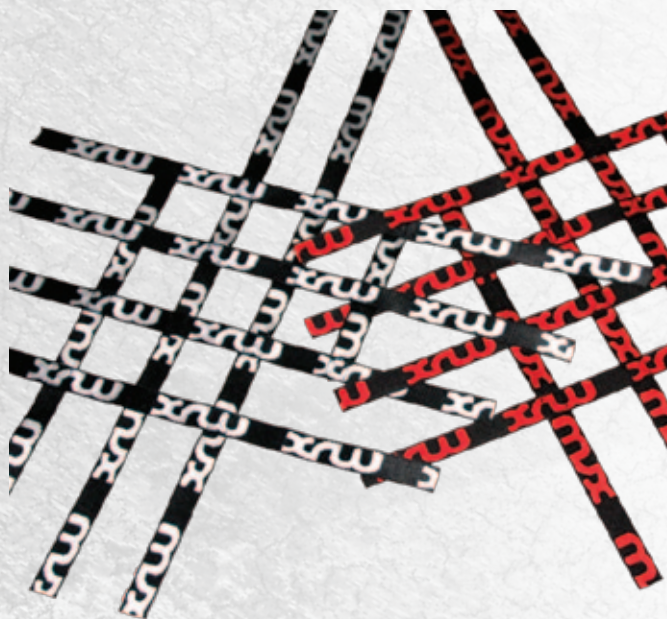

- - Fitas/ Belt Nerf Bar Q1
- - Fitas/ Belt Nerf Bar Q2

REF	Modelo/ Models	
130050504FP	YAMAHA YFM 700 R	●
130050506FP	YAMAHA YFM 700 R	●
130052002FP	YAMAHA 350 BANSHEE	●
130053504FP	YAMAHA YFZ 450	●
130053506FP	YAMAHA YFZ 450	●
130054504FP	YAMAHA YFZ 450 R	●
130054506FP	YAMAHA YFZ 450 R	●
130100504FP	SUZUKI LTR 450	●
130100506FP	SUZUKI LTR 450	●
130101005FP	SUZUKI LTZ 400	●
130101007FP	SUZUKI LTZ 400	●
130101505FP	SUZUKI LTZ 400 K9	●
130101507FP	SUZUKI LTZ 400 K9	●
130252004FP	HONDA TRX 450	●
130252006FP	HONDA TRX 450	●
130252502FP	HONDA TRX 700	●
130252504FP	HONDA TRX 700	●
130300550FP	KTM 450/525 XC	●
130300551FP	KTM 450/525 XC	●
130301050FP	KTM 505- 450 SX	●
130301051FP	KTM 505- 450 SX	●
13040546FP	KAWASAKI KFX 400	●
130401004FP	KAWASAKI KFX 450	●
130401005FP	KAWASAKI KFX 450	●
130450504FP	CAN AM DS 450EFI	●
130451004FP	CAN AM DS 450 XMX	●
130451504FP	CAN AM DS 650	●

Nome: Correias Nerf Bar Q1
 Composição: Tecidas em Polipropileno
 Características: Diversa cores/ XRW branco ou vermelho

Name: Belt Ner Bar Q1
 Composition: Woven in polypropylene
 Technical features: Several colors/ XRW white or red

PLACA NUMERO PHD

PHD PLATE NUMBER

REF	Nome/ Name	Modelo/ Models
130100555PH	Apoio Número Competição / Support Number Competition - PHD	SUZUKI LTR 450
130100556PH	Placa N° PHD (Pega Origem)/ PHD Plate (Original Grab Bar)	SUZUKI LTR 450

Nome: Placa N° PHD (para Pega Origem)
 Composição: PEHD 300 - (Polietileno de Alta Densidade)
 Características: Chapa (esp.) 6 mm

Name: PHD Plate N° (For Original Grab Bar)
 Composition: PEHD 300 - (High Density Polyethylene)
 Technical features: Plate (thickness) 6 mm



FORRA AMORTECEDOR "NYLON" SHOCK COVER "NYLON"

REF	Modelo/ Models
130050511NY	YAMAHA YFM 700 R
130051003NY	YAMAHA YFS200 Blaster
130051504NY	YAMAHA YFM 350 WARRIOR
130052006NY	YAMAHA 350 BANSHEE
130052506NY	YAMAHA YFM 350R
130053005NY	YAMAHA YFM 660R
130053513NY	YAMAHA YFZ 450
130054511NY	YAMAHA YFZ 450 R
130100511NY	SUZUKI LTR 450
130101012NY	SUZUKI LTZ 400
130101512NY	SUZUKI LTZ 400 K9
130251007NY	HONDA TRX 400 EX
130251507NY	HONDA TRX 400 EX - 2008
130252010NY	HONDA TRX 450
130252505NY	HONDA TRX 700
130300509NY	KTM 450/525 XC
130301009NY	KTM 505- 450 SX
130400507NY	KAWASAKI KFX 400
130450510NY	CAN AM DS 450EFI
130451010NY	CAN AM DS 450 XMX
130700507NY	ARTIC CAT DVX 400

Nome: Forra Amortecedor "Nylon"
Composição: Nylon Ecotravel (plastificado)
Características: Plastificado

Name: Shock Cover "Nylon"
Composition: Nylon Ecotravel (Plasticized)
Technical features: Plasticized

FORRA AMORTECEDOR "NEOPRENO" SHOCK COVER "NEOPRENE"

REF	Modelo/ Models
22501Y700NE	YAMAHA YFM 700 R
22502Y660NE	YAMAHA YFM 660
22503Y350NE	YAMAHA YFM 350
22504Y450NE	YAMAHA YFZ 450
22505YBANNE	YAMAHA BANSHEE
22506YWARNE	YAMAHA WARRIOR
22507YBLANE	YAMAHA BLASTER
22508S400NE	SUZUKI LTZ 400
22509S450NE	SUZUKI LTR 450
22510S400NE	SUZUKI LTZ 400 K9
22511K250NE	KYMCO 250
22512H400NE	HONDA TRX 400
22513H450NE	HONDA TRX 450
22514H700NE	HONDA TRX 700
22515K400NE	KAWAZAKI KFX 400
22516K450NE	KAWAZAKI KFX 450
22517K700NE	KAWAZAKI KFX 700
22518P500NE	POL.PREDATOR 500
22519P500NE	POL.OUTLAW 500
22520P525NE	POL.OUTLAW 525/08
22521C800NE	CAN AM RENEGADE 500/800
22522K525NE	KTM 450/525 XC
22523YMONNE	YAMAHA 450 MONSTER

Nome: Forra Amortecedor "Neopreno"
Composição: Neopreno
Características: Neopreno

Name: Shock Cover "Neoprene"
Composition: Neoprene
Technical features: Neoprene



xrw

RACING PARTS

**XRW, Fabrico de Peças Metálicas, Lda.
Rua D - Zona Industrial Vila Verde Sul, Lote 3
3770-305 Oliveira do Bairro
Portugal**

T. +351 234 743 030

F. +351 234 742 047

www.xrwracing.com

xrw@xrw.pt / geral@xrw.pt

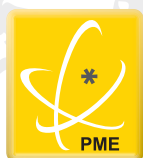

excelência'13



excelência'14